

Operating Instructions

Fronius Wattpilot

Go 11 J 2.0 / 22 J 2.0

Go 22 J 2.0 AUS

Home 11 J 2.0 / 22 J 2.0

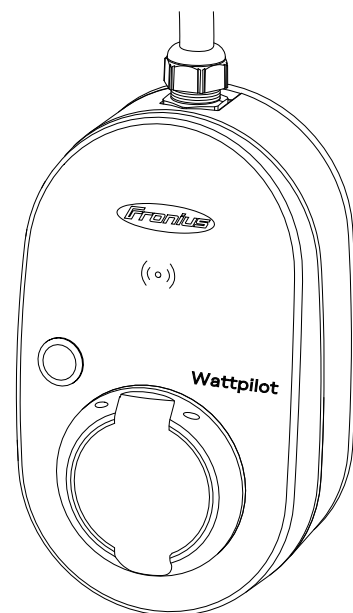

Contents

General information	5
Safety rules	7
Explanation of safety notices	7
General	7
Environmental conditions	8
Qualified personnel	8
EMC measures	8
Data protection	8
Copyright	8
General	9
Intended use	9
Symbols on the device	9
Scope of supply	9
Accessories	10
Safety	11
Suitable inverters	13
Suitable generators from third-party manufacturers	14
Controls and indicators	15
Product overview	15
Card reader	15
Pushbutton functions	15
ID chip	16
Reset card	16
LED status indicator	17
Functions	22
Overview	22
Phase changeover	22
PV surplus	22
Flexible electricity tariff	25
Different charging modes	26
Standard mode	26
Eco Mode	26
Next Trip Mode	27
Dynamic load balancing	30
General	30
Functional principle	30
Priority	31
Videos	33
Webinars and How-to videos	33
Installation and commissioning	35
Installation location and position	37
Choice of location	37
Installation position	37
Installation	39
Mounting the Wattpilot on the wall	39
Mounting the anti-theft protection	40
Connecting the Wattpilot	42
General information	42
Installing the Wattpilot Home	42
Backup power mode	43
Commissioning	43
Stopping charging	44
Data communication with the inverter	44
Fronius Solar.wattpilot app	47

Overview	49
General.....	49
Download.....	49
Connecting via WLAN	50
Launching the app.....	50
Setting up a hot spot.....	50
Setting up the WLAN	50
Adding a Wattpilot	50
Charging.....	51
Homepage.....	51
Energy per user	52
Settings.....	53
Current level.....	53
Next Trip Mode	53
Cost optimisation	53
Charging timer.....	55
Load Balancing.....	55
Name.....	56
Brightness.....	56
LED colours.....	56
Time zone	56
Access management.....	56
Cable release	57
Earthing test.....	57
ID chips	58
Password	58
Grid settings	58
Internet.....	60
Connection.....	60
OCPP.....	60
Restart.....	60
Firmware update.....	61

Appendix 63

General.....	65
Residual current detection.....	65
Safety functions.....	65
Standard settings.....	65
Technical data.....	69
Wattpilot Go 11 J 2.0.....	69
Wattpilot Go 22 J 2.0.....	69
Wattpilot Go 22 J 2.0 AUS	70
Wattpilot Home 11 J 2.0	71
Wattpilot Home 22 J 2.0	72
Status codes and remedy	73
Status Codes	73
Warranty terms and conditions, and disposal	76
Fronius manufacturer's warranty.....	76
Disposal.....	76

General information

Safety rules

Explanation of safety notices

DANGER!

Indicates immediate danger.

- ▶ If not avoided, death or serious injury will result.

WARNING!

Indicates a potentially hazardous situation.

- ▶ If not avoided, death or serious injury may result.

CAUTION!

Indicates a situation where damage or injury could occur.

- ▶ If not avoided, minor injury and/or damage to property may result.

NOTE!

Indicates a risk of flawed results and possible damage to the equipment.

General

Follow these Operating Instructions to ensure safe and proper use of the device. Keep for later reference.

The device has been manufactured in line with the state of the art and according to recognised safety standards. If used incorrectly or misused, however, it can cause:

- Serious or fatal injury to the operator or third parties
- Damage to the device and other material assets belonging to the operating company

All personnel involved in commissioning, maintenance and servicing of the device must:

- Be suitably qualified
- Have knowledge of and experience in dealing with electrical installations
- Have fully read and precisely followed these Operating Instructions

In addition to the Operating Instructions, all applicable local rules and regulations regarding accident prevention and environmental protection must also be followed.

All safety and danger notices on the device:

- Must be kept in a legible state
- Must not be damaged
- Must not be removed
- Must not be covered, pasted or painted over

Only operate the device when all connections and protection devices are fully functional. If the connections and protection devices are not fully functional, there is a danger of

- Serious or fatal injury to the operator or third parties
- Damage to the device and other material assets belonging to the operating company

Any safety devices that are not fully functional must be repaired by an authorised specialist before the device is switched on.

Never bypass or disable protection devices.

For the meaning of the safety and danger notices on the device, refer to the section headed "Information on the device".

Any equipment malfunctions which might impair safety must be remedied before the device is turned on.

This is for your personal safety!

Environmental conditions

Operation or storage of the device outside the stipulated area will be deemed as not in accordance with the intended purpose. The manufacturer accepts no liability for any damage resulting from improper use.

Qualified personnel

The information on mounting and installing the device contained in these Operating Instructions is intended only for the use of qualified service engineers. Do not carry out any actions other than those described in the documentation. This also applies to qualified personnel.

Maintenance and repair work must only be carried out by an authorised specialist.

EMC measures

In certain cases, even though a device complies with the standard limit values for emissions, it may affect the application area for which it was designed (e.g., when there is equipment that is susceptible to interference at the same location, or if the site where the device is installed is close to either radio or television receivers). If this is the case, then the operator is obliged to take action to rectify the situation.

Data protection

The user is responsible for the safekeeping of any changes made to the factory settings. The manufacturer accepts no liability for any deleted personal settings.

Copyright

Copyright of these operating instructions remains with the manufacturer.

The text and illustrations are all technically correct at the time of printing. We reserve the right to make changes. The contents of the operating instructions shall not provide the basis for any claims whatsoever on the part of the purchaser. If you have any suggestions for improvement, or can point out any mistakes that you have found in the instructions, we will be most grateful for your comments.

Intended use

The Fronius Wattpilot Go 11 J 2.0 / Go 22 J 2.0 / Go 22 J 2.0 AUS is a mobile charging station for charging electric vehicles for connection to an AC/three-phase network.

The Fronius Wattpilot Home 11 J 2.0 / Home 22 J 2.0 is a charging station for charging electric vehicles for fixed connection to an AC/three-phase network.

The Wattpilot may only be used for the purpose of charging battery-powered electric vehicles and plug-in hybrid vehicles in conjunction with the appropriate adapters and cables.

Intended use also includes complying with all the instructions in these Operating Instructions.

The following circumstances are considered improper:

- Use other than or in excess of the intended use.
- Making any modifications to the Wattpilot that have not been expressly approved by Fronius.
- Installation of components that are not distributed or expressly approved by Fronius.

The manufacturer shall not be liable for any damage resulting from such use. All warranty claims will be forfeited.

Symbols on the device

The symbols on the Fronius Wattpilot must not be removed or painted over. They warn against incorrect operation, as this may result in serious injury and damage.

Symbols on the rating plate:

 CE mark – confirms compliance with applicable EU directives and regulations. The product has been tested by a specific notified body.

 WEEE mark – waste electrical and electronic equipment must be collected separately and recycled in an environmentally sound manner in accordance with the European Directive and national law.

 RoHS marking - The product complies with the requirements of the EU Directive on the restriction of the use of certain hazardous substances in electrical and electronic equipment. See [RoHS statement](#).

 UKCA mark – confirms compliance with applicable UK directives and regulations.

 RCM mark – tested in accordance with the requirements of Australia and New Zealand.

Scope of supply Depending on the product variant, the scope of delivery differs as follows.

Fronius Wattpilot Go 11 J 2.0 / Go 22 J 2.0 / Go 22 J 2.0 OFF*

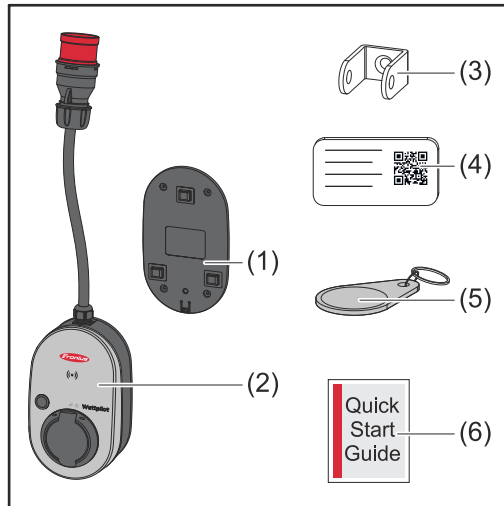

- (1) Mounting bracket, incl. screws and dowels
- (2) Wattpilot Go 11 J 2.0 or Wattpilot Go 22 J 2.0
- (3) Anti-theft device
- (4) Reset card
- (5) ID chip
- (6) Quick Guide

*The scope of delivery for the Fronius Wattpilot Go 22 J 2.0 AUS differs from the other product variants by the plug type.

Fronius Wattpilot Home 11 J 2.0 / Home 22 J 2.0

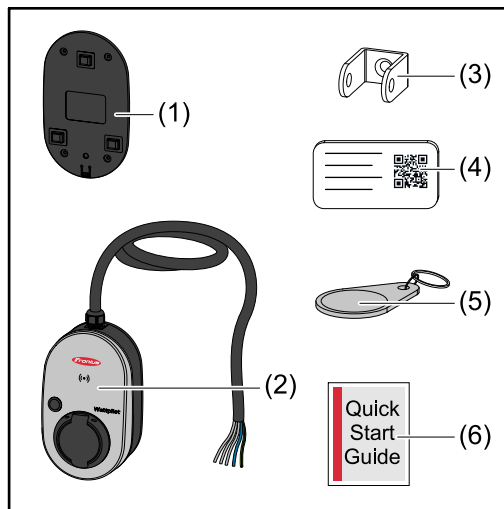

- (1) Mounting bracket, incl. screws and dowels
- (2) Wattpilot Home 11 J 2.0 or Wattpilot Home 22 J 2.0
- (3) Anti-theft device
- (4) Reset card
- (5) ID chip
- (6) Quick Guide

Accessories

NOTE!

Only use original adapters for the operation of the Wattpilot!

The CEE plugs (see IEC 60309) of the adapter set differ from those of other suppliers due to their design with a reed contact.

- Use original adapter sets.

Accessories, optional

Item designation	Item number
Type 2 charging cable, 32 A, 22 kW, 2.5 m	4,240,419
Type 2 charging cable, 32 A, 22 kW, 5.0 m	4,240,180
Type 2 charging cable, 32 A, 22 kW, 7.5 m	4,240,420
ID chips, 10 pieces	4,240,181

Item designation	Item number
Mounting plate Go 2.0 (mounting bracket)	4,240,421
Type 2 wall bracket (cable wall bracket)	4,240,422
Adapter set Go 11 2.0, CEE adapter 16 A to - CEE plug, red, 32 A (3-phase) - CEE plug, blue, 16 A (1-phase, camping plug) - Earthed plug type F 16 A (household socket)	4,240,405
Adapter Go 11 CEE32 red 2.0, (3-phase)	4,240,406
Adapter Go 11 CEE16 blue 2.0, (1-phase)	4,240,407
Adapter Go 11 type F plug 2.0 (household socket)	4,240,408
Adapter set Go 22 2.0, CEE adapter 32 A to - CEE plug, red, 16 A (3-phase) - CEE plug, blue, 16 A (1-phase, camping plug) - Earthed plug type F 16 A (household socket)	4,240,410
Adapter Go 22 CEE16 red 2.0, (3-phase)	4,240,411
Adapter Go 22 CEE16 blue 2.0, (1-phase)	4,240,412
Adapter Go 22 type F plug 2.0 (household socket)	4,240,413

Safety

WARNING!

Danger due to incorrect operation and incorrectly performed work.

This can result in serious injury and damage to property.

- ▶ Read and understand this document.
- ▶ Read and understand all the Operating Instructions for the system components, especially the safety rules.

WARNING!

Danger from electromagnetic fields for persons with pacemakers and defibrillators!

This can result in serious injury.

- ▶ Persons with pacemakers must maintain a distance of at least 60 cm.
- ▶ Persons with defibrillators must maintain a distance of at least 40 cm.

WARNING!

Danger due to open or damaged housing!

This can result in severe personal injury and damage to property due to high voltage and/or fire.

- ▶ Do not use the device if the housing is damaged or open.
- ▶ Send in the device for repair.

 **WARNING!**

Danger from loose parts in the housing!

This can result in severe personal injury and damage to property due to high voltage and/or fire.

- ▶ Do not use the device if there are loose parts in the housing.
 - ▶ Send in the device for repair.
-

 **WARNING!**

Danger due to cables!

Damaged or exposed cables can result in severe personal injury and damage to property.

- ▶ Do not use the device if the cables attached to or plugged into the device are damaged.
 - ▶ Adequately support the weight of the device and the charging cable.
 - ▶ Provide mechanical relief for the cables.
 - ▶ Lay the charging cable securely to avoid the risk of tripping over the charging cable.
-

 **WARNING!**

Danger due to wet or dirty connectors!

Charring caused by prolonged usage can result in severe personal injury and damage to property.

- ▶ Only mount the device vertically.
 - ▶ Dry wet connectors in a de-energised state.
 - ▶ Clean soiled connectors in a de-energised state.
-

 **WARNING!**

Danger from gassing vehicle batteries!

This can result in serious injury.

- ▶ Only use in well-ventilated areas.
-

 **WARNING!**

Danger from driving away with the charging cable connected!

This can result in severe personal injury or damage to property.

- ▶ Disconnect the charging cable from the electric vehicle before driving away.
 - ▶ Do not bypass the safety device of the electric vehicle.
-

 **WARNING!**

Danger due to excessive load!

This can result in severe personal injury or damage to property.

- ▶ The load when operating the device with an earthed plug must not exceed 10 A.
 - ▶ The earthed socket outlet must be suitable for continuous operation at 10 A.
 - ▶ Check for heat generation after each use.
 - ▶ The device and the sockets must not overheat.
-

 **CAUTION!**

Danger due to excessive charging current!

Fires or damage to the in-house installation may result.

- ▶ Observe the maximum permissible current at the connected socket.
- ▶ If the maximum charging current is not known, charge with the lowest possible charging current.
- ▶ Only use original adapters. An automatic reduction of the charging current to 16 A by plugging in the adapter is only possible in conjunction with the original adapters.

 **CAUTION!**

Danger due to heat generation on the device!

The build-up of heat can lead to lasting damage and even fire.

- ▶ Never cover the device during charging.
- ▶ Unwind the cable completely from a cable drum.
- ▶ Observe the correct installation position.

Never pull the plug out of the plug connection by the cable!

Observe the specifications of the grid operator regarding 1-phase charging and the asymmetrical network load that may result.

The device has a built-in residual current protection module with residual current detection (20 mA AC and 6 mA DC). This means that no upstream type B residual-current circuit breaker is required. A separate type A residual-current circuit breaker and an automatic circuit breaker must be connected upstream for each Wattpilot.

The device may only be operated at the following connections:

- CEE red 32 A, 3-phase, 400 V
- CEE red 16 A, 3-phase, 400 V
- With original adapters:
 - CEE red 16 A, 3-phase, 400 V
 - CEE red 32 A, 3-phase, 400 V
 - CEE blue 16 A, 1-phase, 230 V
 - Earthed plug 16 A, 1-phase, 230 V

In case of defective adapters or defective CEE plugs, send the device in for repair.

Suitable inverters

Compatibility with the connected devices, suitable data communication and a Fronius Smart Meter at the feed-in point are prerequisites for using some Wattpilot functions (e.g. PV surplus).

Suitable Fronius inverters

- Fronius GEN24
- Fronius Symo Hybrid
- Fronius SnapINverter (except light versions)
- Fronius IG*
- Fronius IG Plus*
- Fronius IG TL**
- Fronius CL*

*Requirement:

- Fronius Smart Meter
- Fronius Datamanager 2.0 (item number 4,240,036,z), or
- Fronius Datamanager Box 2.0 (item number 4,240,125)

**Requirement:

- Fronius Datamanager Box 2.0 (item number 4,240,125)

Suitable generators from third-party manufacturers

Suitable generators can be, for example, inverters or wind power plants. A prerequisite for compatibility with external generators is that no other self-consumption controllers (with e.g. battery, power-to-heat) are operated in parallel. This can lead to photovoltaics optimisation (PV optimisation) malfunctions. The proportion of energy consumed by other loads is not taken into account in the Fronius Solar.wattpilot app, as the power is only known at the grid connection point.

Requirement:

- Fronius Smart Meter (at the feed-in point)
- Fronius Datamanager Box 2.0 (item number 4,240,125)

For further information see [Data communication with the inverter](#) on page 44.

Controls and indicators

Product overview

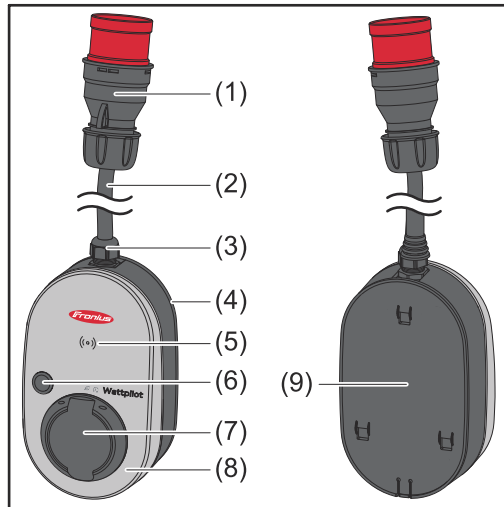

- (1) CEE plug
- (2) Connection cable
- (3) Strain-relief device
- (4) Housing
- (5) Card reader
- (6) Pushbutton
- (7) Type 2 junction box
- (8) LED ring
- (9) Rating plate

Symbols on front of the device:



Kartenleser

The symbol shows the location of the card reader installed in the device where ID chips can be authenticated or taught-in or the Wattpilot can be reset using the reset card.



Eco Mode

This symbol indicates operation in Eco Mode; the first LED lights up white.



Next Trip Mode

This symbol indicates operation in Betrieb im Next Trip Mode; the second LED lights up white.

Card reader

Behind the symbol ((◉)) is the card reader for reading ID chips and the reset card.

The card reader uses RFID (radio-frequency identification). RFID is the transmitter-receiver technology for automatic and contactless identification with radio waves.

Pushbutton functions

By pressing the pushbutton, the level of charging current can be adjusted or the operating mode can be changed.

Press for under 0.5 s

Briefly pressing the pushbutton changes the operating mode. The charging modes are

- Standard mode
- Eco Mode
- Next Trip Mode

The selected charging mode (see [Different charging modes](#) on page 26) is indicated by the LED status indicator (see [LED status indicator](#) on page 17); in standard mode, no operating mode LEDs light up.

Pressing for more than 2.0 s

Pressing the pushbutton repeatedly changes the preset charging current (in amperes). The level of the set charging current is indicated by the LED status indicator (see [LED status indicator](#) on page 17).

The level of the preset charging current can be adjusted in the app (see [Current level](#) on page 53).

Standard settings

- Fronius Wattpilot Go 11 J 2.0 / Home 11 J 2.0: 6 A, 10 A, 12 A, 14 A, 16 A
- Fronius Wattpilot Go 22 J 2.0 / Go 22 J 2.0 AUS: 10 A, 16 A, 20 A, 24 A, 32 A

ID chip

The ID chip can be used to personalise access to the Fronius Wattpilot. The ID chip is used for authentication and for recording user-specific charging amounts.

In the app settings, authentication for charging can be activated under "Access management" and "Authentication required" (see [Access management](#) on page 56). Charging with authentication activated can be carried out after scanning the supplied ID chip or by providing confirmation in the app. To scan, hold the ID chip directly in front of the card reader of the Wattpilot.

Each ID chip can be assigned a name in the app under "ID chips". The stored charging amount per ID chip can be viewed in this menu (see [ID chips](#) on page 58).

No authentication is required in order to assign the charging amount to the ID chips.

Reset card

The reset card resets all settings (e.g. access management, WLAN and LED settings) to the factory settings. The taught-in ID chips and the corresponding charging amounts continue to be stored.

The following information is printed on the reset card.

- "Serial number" - serial number of the Wattpilot
- "Hot spot SSID" - WLAN network name of the Wattpilot
- "Hot spot key" - WLAN password of the Wattpilot
- "QR code" - key to connect the app to the Wattpilot hot spot

Resetting the Wattpilot

- 1 Hold the reset card in front of the card reader.
- 2 All LEDs briefly light up red.



NOTE!

Keep the reset card safe!

The reset card contains all access data.

► **TIP:** Keep the reset card in the car.

LED status indicator

The LED status indicator on the Wattpilot indicates whether the system is switched on and the current system status of the Wattpilot. One LED represents one ampere (1 A). A maximum of 32 A is displayed. The first two LEDs indicate the currently active operating mode. If these do not light up white, the Wattpilot is in standard mode - charging takes place with the maximum set current without taking surplus PV electricity and flexible electricity tariffs into account.



Eco Mode

The Wattpilot is in Eco Mode.

- The first LED lights up white.
- The first LED flashes orange (see chapter [Status Codes](#) on page 73).
- The first LED flashes red (see chapter [Status Codes](#) on page 73).



Next Trip Mode

The Wattpilot is in Next Trip Mode.

- The second LED lights up white.
- The second LED flashes orange (see chapter [Status Codes](#) on page 73).
- The second LED flashes red (see chapter [Status Codes](#) on page 73).

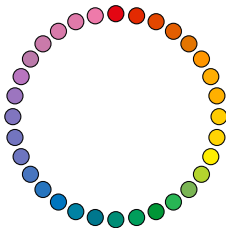

Starting

The Wattpilot is starting up or restarting.

- The LEDs light up in rainbow colours.

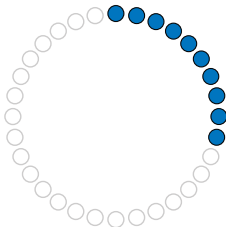

Ready

The Wattpilot is ready for operation. The number of LEDs that light up indicates the set charging current. Each LED represents 1 ampere (A). A maximum of 32 A can be displayed, whereby the first two LEDs are reserved for the charging modes.

- A few blue LEDs light up = low charging current (e.g. 10 LEDs = 10 A).
- Several/all blue LEDs light up = high charging current (e.g. 32 LEDs = 32 A).

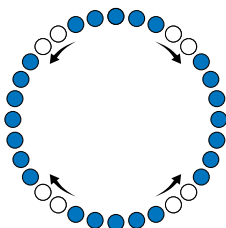
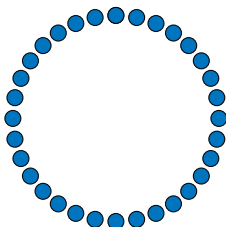

Enable

The Wattpilot must be activated via the app or an ID chip.

- The LEDs light up blue, four pairs of LEDs run in a quarter circle from the top and bottom towards each other.

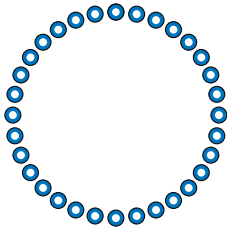

Waiting

The Wattpilot is waiting for cheap electricity from a photovoltaic system or electricity provider, or the charging timer is active.

- The LEDs flash blue in the number of amperes set.

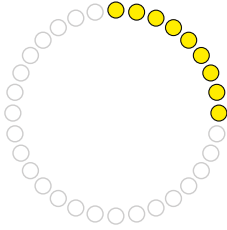

Wait for car

The Wattpilot recognises the connected vehicle and the set charging parameters. Charging has been enabled by the charging station but not yet started by the car.

- A few yellow LEDs light up when the charging current is low.
- Several/all yellow LEDs light up when the charging current is high.

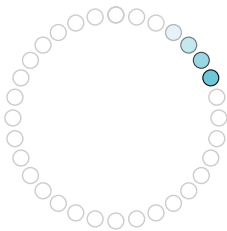
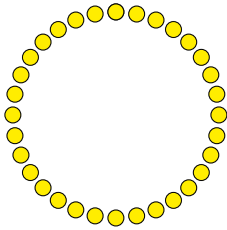

1-phase charging

The Wattpilot is carrying out 1-phase (230 V) charging with low to high charging current.

- One series of blue LEDs moves in a clockwise direction.
- The level of charging current is indicated by the number of LEDs and the speed of rotation.

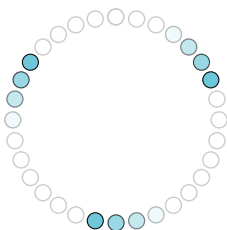
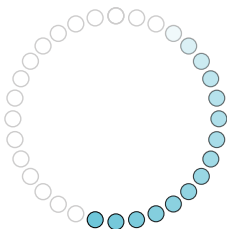

3-phase charging

The Wattpilot is carrying out 3-phase (400 V) charging with low to high charging current.

- Three series of blue LEDs move in a clockwise direction.

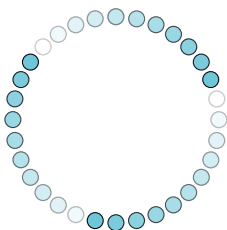

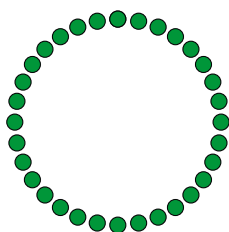

Charging finished

The charging process is complete.

- All LEDs light up green.

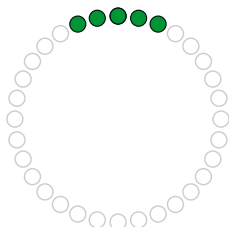

ID chip detected

The Wattpilot has detected an authorised ID chip.

- Five LEDs light up green.

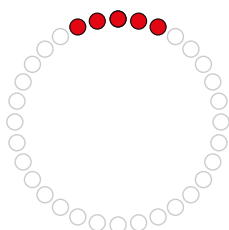

Invalid value

Wattpilot displays an invalid input. Pressing the pushbutton was not permitted or an ID chip was detected but not authorised.

- Five LEDs light up red.

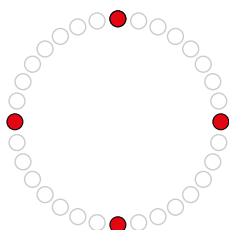

Earthing test deactivated

The earthing test is deactivated.

- Four LEDs light up at 3, 6, 9 and 12 o'clock.

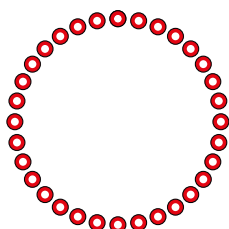

Internal communication fault

The Wattpilot displays an internal communication error. The error code is displayed in the app. For more information, see [Status Codes](#) on page 73.

- All LEDs flash red.

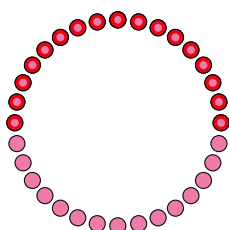

Residual current detected

The Wattpilot has detected a residual current ($\geq 6 \text{ mA}_{\text{DC}}$ or $\geq 20 \text{ mA}_{\text{AC}}$). Restart the Wattpilot. For more information, see [Status Codes](#) on page 73.

- The LEDs light up pink, the LEDs at the top flash red.

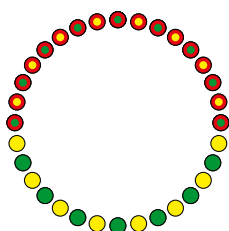

Earth fault detected

The earthing of the supply line to the Wattpilot is faulty. Check the earthing of the supply line. For more information, see [Status Codes](#) on page 73.

- The LEDs light up green and yellow, the LEDs at the top flash red.

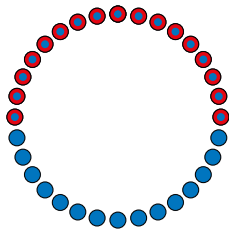

At least one phase of the power supply is missing

The phase(s) of the supply line to the Wattpilot has/have failed. Check the phase(s) of the supply line. For more information, see [Status Codes](#) on page 73.

- The LEDs light up blue, the LEDs at the top flash red.

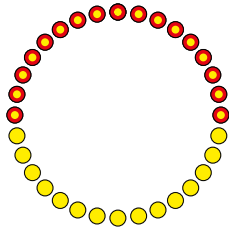

Temperature too high

The temperature of the Wattpilot is too high. The charging current is reduced. For more information, see [Status Codes](#) on page 73.

- The LEDs light up yellow, the LEDs at the top flash red.

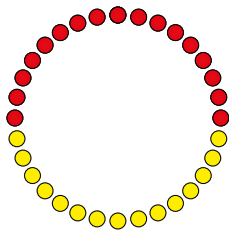

Unlocking or locking error

Unlocking or locking has failed. The unlocking or locking attempt is repeated at 5-second intervals. For more information, see [Status Codes](#) on page 73.

- The LEDs light up red at the top and yellow at the bottom for 1 second.

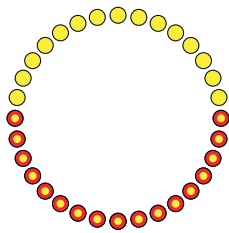

Charge controller error

The charge controller is not working properly. For more information, see [Status Codes](#) on page 73.

- The LEDs light up red at the top and yellow at the bottom for 1 second.

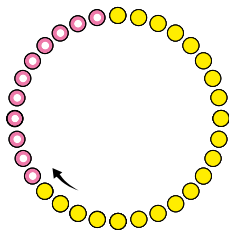

Update

The Wattpilot firmware is being updated. The update can take several minutes. Do not unplug the charging station.

- All LEDs flash pink, the progress of the update is indicated by yellow LEDs.

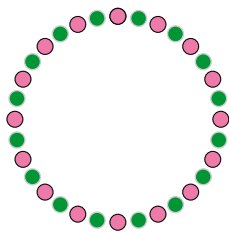

Update successful

- The LEDs light up alternately pink and green.

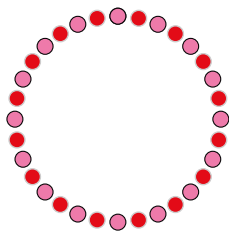

Update failed

- The LEDs light up alternately pink and red.
-

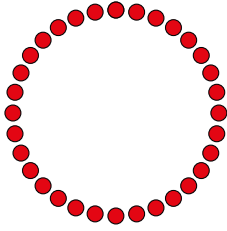
**Reset card detected**

The Wattpilot has detected the reset card and the settings are reset.

- All LEDs light up red for 2 seconds.
-

Functions

Overview

The Wattpilot can be used like any other charging station. For start-up, the charging cable must be plugged in and the Wattpilot starts charging. By pressing the pushbutton (see [Pushbutton functions](#) on page 15) it is possible to switch between the charging modes (see [Different charging modes](#) on page 26) and change the level of charging current (see [Current level](#) on page 53).

Phase changeover

The Fronius Wattpilot can automatically switch between 1-phase and 3-phase charging. The automatic phase changeover enables charging with a low start-up power (1-phase with 1.38 kWh) in the case of a PV surplus. In addition, 1-phase charging has the advantage that the charging power can be regulated in smaller increments (0.23 kW) and a small PV surplus can be used more efficiently. As 1-phase charging is limited by the car, it makes sense to switch to 3-phase charging at a higher PV surplus. This allows higher maximum charging outputs to be achieved.

The phase changeover can be set automatically or manually (see [PV surplus](#) on page 22).

NOTE!

Do not exceed the phase-load imbalance!

Select the phase changeover point in such a way that the maximum permissible phase-load imbalance is not exceeded.

PV surplus

NOTE!

A minimum charging time of 5 minutes is stored.

To prevent permanent switching of the relays and to increase the service life of the Wattpilot, a minimum charging time of 5 minutes is stored.

The surplus energy of a PV system (photovoltaic system) can be used. The prerequisites for this are a compatible inverter in the same network as the Wattpilot and a Fronius Smart Meter (for more information, see [Data communication with the inverter](#) on page 44).

Setting limit values ensures that the available PV surplus power is distributed to the loads. The limit values created allow an energy storage system to be sufficiently charged or the energy to be stored in the form of hot water before the surplus PV power is used to charge a vehicle.

NOTE!

PV surplus regulation.

One Wattpilot per photovoltaic system.

- ▶ The PV surplus regulation works with one Wattpilot per photovoltaic system.
 - ▶ If several Wattpilot devices are connected to one inverter, "Use PV surplus" may only be activated on one Wattpilot. For all other Wattpilot devices, "Use PV surplus" must be deactivated (for more information, see [Cost optimisation](#) on page 53).
-

It is possible to set a **start-up power level** (specified in kilowatts/kW). This must be reached by the photovoltaic system before the Wattpilot starts charging the car with the minimum current.

It is possible to set a **3-phase power level** (specified in kW). This must be reached by the photovoltaic system before the Wattpilot switches from 1-phase to 3-phase charging.

The settings for the start-up power level and 3-phase power level can be made under **Cost optimisation** in the **Fronius Solar.wattpilot app**.

The power level can only be regulated in increments of 1 ampere. The table below lists the charging current in amperes (A) and the corresponding charging power for 1-phase and 3-phase charging in kilowatts (kW). 1-phase in 0.23 kW increments, 3-phase in 0.69 kW increments. The values are based on the assumption that the voltage is exactly 230 or 400 V.

- Example: The charging current is increased by 1 A to 7 A.
 - 1-phase: 1.38 kW + 0.23 kW = 1.61 kW
 - 3-phase: 4.14 kW + 0.69 kW = 4.83 kW

Charging current (A)	6	8	10	12	14	16	20	24	32
1-phase [kW]	1.38	1.84	2.3	2.76	3.22	3.68	4.6	5.52	7.36
3-phase [kW]	4.14	5.52	6.9	8.28	9.66	11	13.8	16.56	22

Example

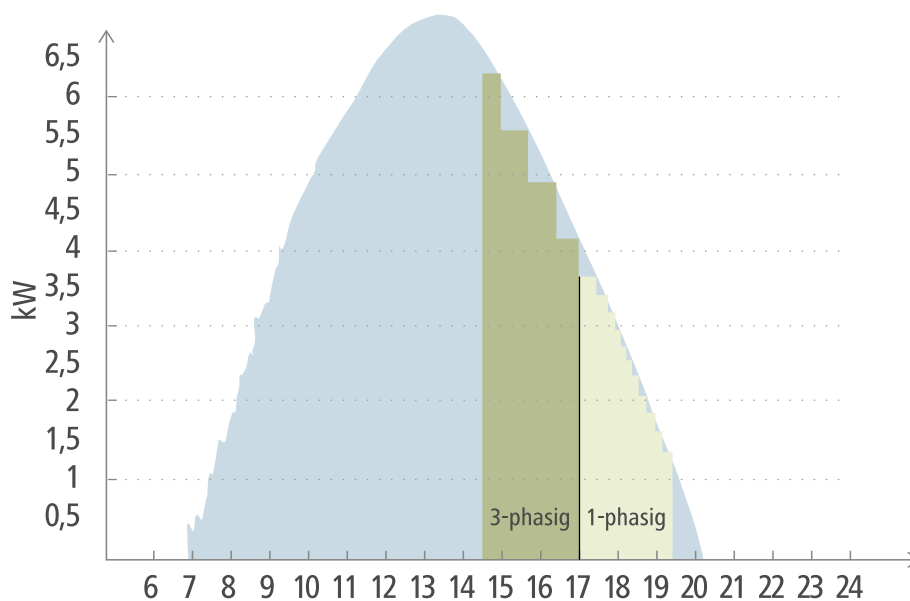

- Photovoltaic generation
- Electric vehicle

The figure illustrates the behaviour of the Wattpilot with a set start-up power level of 1.38 kW and a 3-phase power level of 4.14 kW. If the PV surplus is less than 1.38 kW, the vehicle is not charged.

If the PV surplus is between 1.38 and 4.14 kW, the Wattpilot regulates the charging power in **0.23 kW** increments.

If the PV surplus is above 4.14 kW, the Wattlepilot switches from 1-phase charging to 3-phase charging and regulates the charging power in **0.69 kW** increments.

NOTE!

The minimum charging power of electric vehicles is usually 1.38 kW.

In the case of smaller photovoltaic systems, it may make sense to set the start-up power level below 1.38-kW so that sufficient energy is charged. The electricity that is not covered by the photovoltaic system, however, is drawn from the grid. This results in a power mix of self-consumption and grid supply.

- ▶ A start-up power level below 1.38 kW results in a power mix.

Charging with PV surplus can be activated and adjusted in the Fronius Solar.wattlepilot app (see **Cost optimisation** on page 53).

Priorities in the system between battery, Ohmpilot and Wattlepilot

The priority of the Wattlepilot can be influenced via the "PV battery limit value" and "Ohmpilot limit value" settings in the Fronius Solar.wattlepilot app (see chapter **Cost optimisation** on page 53). Depending on the level of the selected limit values, it is possible to define under which conditions the charging of the electric vehicle starts. The temperature limit value of the Ohmpilot can only be used if a temperature sensor is connected to the Ohmpilot. To set the Wattlepilot priority, the energy management priority settings on the user interface of the inverter must also be taken into account.

NOTE!

If no temperature sensor is connected to the Fronius Ohmpilot, a temperature of 0 °C is assumed. If the Wattlepilot is to be prioritised over the Ohmpilot, the "Ohmpilot limit value" must be set to 0 °C. In the event of a sensor break, the Ohmpilot is supplied with power before the Wattlepilot.

Example: Charging the electric vehicle first

The electric vehicle must always be charged with PV surplus before the battery and the Ohmpilot. In the Solar.wattlepilot app, the limit value for the battery is set to 0% and the limit value for the Ohmpilot is set to 0 degrees. The electric vehicle is immediately charged with PV surplus, regardless of the state of charge of the battery or the temperature of the Ohmpilot.

- **System with inverter, Wattlepilot, battery and Ohmpilot**

Priority in the inverter	Wattlepilot	Battery**	Ohmpilot
Battery** > Ohmpilot	Priority 3 until SOC* and temperature limit value reached, then 1	Priority 1 until SOC*, then 2	Priority 2 until temperature limit value reached, then 3
Ohmpilot > Battery**	Priority 3 until SOC* and temperature limit value reached, then 1	Priority 2 until SOC, then 3	Priority 1 until temperature limit value reached, then 2

- **System with inverter, Wattlepilot and Ohmpilot**

Priority in the inverter	Wattpilot	Ohmpilot
Ohmpilot	Priority 2 until temperature limit value reached, then 1	Priority 1 until temperature limit value reached, then 2

- **System with inverter, Wattpilot and battery**

Priority in the inverter	Wattpilot	Battery**
Battery**	Priority 2 until SOC*, then 1	Priority 1 until SOC*, then 2

*SOC - State of Charge of the stationary battery

**Fronius-compatible DC coupled battery

NOTE!

The component with the highest priority in the inverter is taken into account. If, for example, a battery in the inverter is prioritised higher than an Ohmpilot and the battery limit value is set to 50% and the Ohmpilot limit value is set to 50 °C, the Wattpilot will start charging when the battery reaches 50% SOC. The Ohmpilot is not supplied with energy until the electric vehicle and battery are fully charged.

IMPORTANT!

The energy management with the digital outputs (I/Os) on the Fronius inverter **must not** be used for load management of the Wattpilot! The priorities of the loads are not clearly assigned.

Flexible electricity tariff

The flexible electricity tariff can be used if electricity is purchased from electricity retailers and charged for hourly via the electricity exchange, e.g.

- Lumina Strom hourly (available in Germany, as at 01/03/2021) or
- aWattar hourly (available in Austria and Germany, as at 01/03/2021).

The Wattpilot queries the retailer tariffs directly via the Internet. It is possible to specify a price threshold (Eco Mode price limit) below which charging starts. This is the pure electricity price, without network charges or other fees.

Example

The following figure shows the electricity price of an electricity retailer (Lumina Strom hourly, aWattar hourly) over 24 hours. The hourly tariffs are retrieved from the electricity exchange at a specific time for the next day.

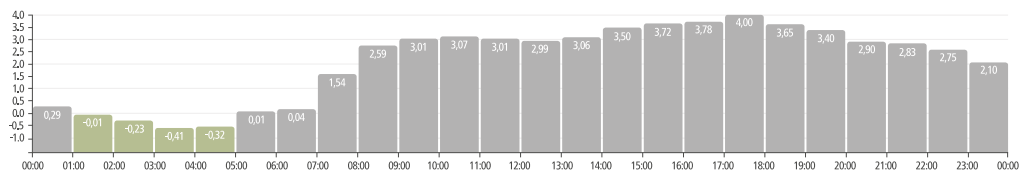

Information regarding electricity retailers with a flexible electricity tariff can be found under

- [Lumina Strom hourly](#) (as at 01/03/2021)
- [aWattar hourly](#) (as at 01/03/2021)

Different charging modes

Standard mode In standard mode, charging takes place at the preset amperage (e.g. 16 A). The level of charging current can be changed by pressing the pushbutton on the Wattpilot. In the app (see **Current level** on page 53), the charging current can be adjusted in 1 ampere increments.

In standard mode, no operating mode LEDs light up.

Whereas charging at a low charging current is gentle, charging at a high charging current enables rapid charging. If necessary, charging is carried out with electricity sourced from the grid.

NOTE!

Standard mode

Standard mode is the standard setting of the Wattpilot; no LEDs light up white. In this charging mode, the PV surplus and the flexible electricity tariff are not taken into account.

- ▶ No further settings are required for standard mode.
-

Eco Mode

In Eco Mode, a vehicle is only charged when low-cost electricity is available. Charging can either take place with cheaply purchased electricity (see **Flexible electricity tariff** on page 25) or surplus energy produced by the photovoltaic system (see **PV surplus** on page 22). There is no guarantee that charging will occur.

Prerequisite

Charging in Eco Mode is only possible if **PV surplus** and/or a **Flexible electricity tariff** is activated under **PV surplus** in the Fronius Solar.wattpilot app.

NOTE!

Change mode for guaranteed charging.

If there is no surplus generated power or cheap electricity available, charging is not carried out in Eco Mode.

- ▶ Change mode for guaranteed charging.
-

Enable

Eco Mode can be configured in the app under **Cost optimisation** on page 53 and activated by pressing the pushbutton (< 0.5 s) or via the Fronius Solar.wattpilot app.

NOTE!

The battery of the photovoltaic system is discharged first!

If the system contains a stationary battery, the battery of the photovoltaic system is discharged when the electricity price falls below the threshold before mains current is drawn.

Example

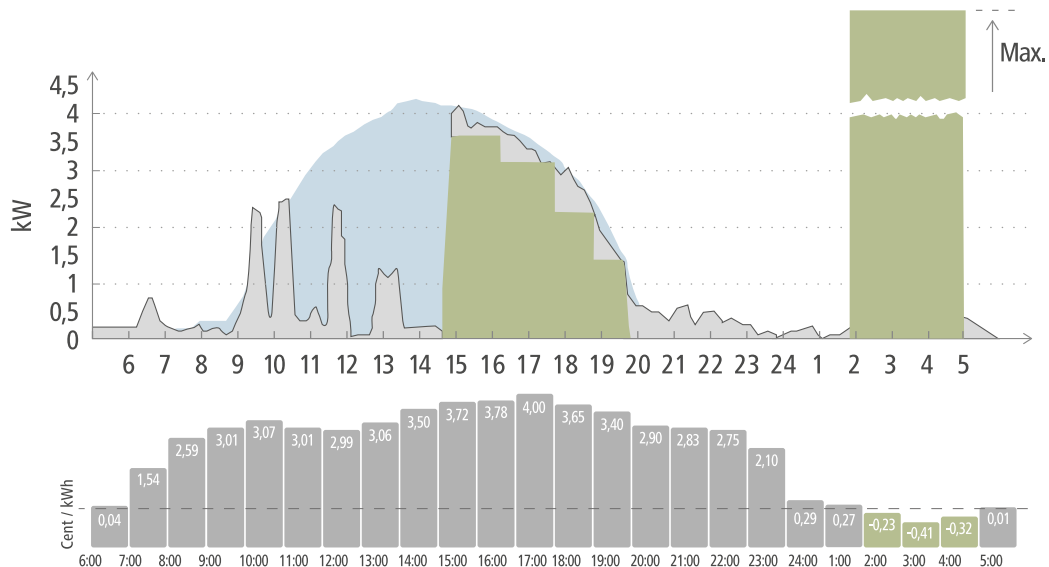

- Photovoltaic generation
- Electric vehicle
- Household consumption

In Eco Mode, the electric vehicle is connected to the Wattlepilot at around 15:00, as although a fixed additional range for the electric vehicle is not necessary, cheaper electricity is to be used for charging. In the Fronius Solar.wattlepilot app, the PV surplus and/or flexible electricity tariff must be activated and set under Cost optimisation. Household consumption is covered by photovoltaic generation and the electric vehicle is charged with the PV surplus. Charging takes place using the PV surplus until around 20:00. Between 02:00 and 05:00, the electricity price falls below the defined price limit. The electric vehicle is charged with cheap electricity during this period.

Charging in Eco Mode

PV surplus	Price limit	Wattlepilot
No	No	No charging
No	Yes	Max. charging
Yes	No	Charging with PV surplus
Yes	Yes	Max. charging

Next Trip Mode

In Next Trip Mode, a vehicle is charged as cheaply as possible until the end of the self-selected time with the set charging amount. The time charging starts is selected in such a way that the desired charging amount is charged at least one hour before the charge end. Charging takes place in the cheapest cost window. The PV surplus and flexible electricity tariff settings are taken into account. If the "Stay in Eco Mode" function (for activation see [Next Trip Mode](#) on page 53) is activated, the Wattlepilot continues charging with low-cost energy after the set charging amount has been reached.

The set charging amount is charged in addition to the charging amount available in the electric vehicle. The charging amount is specified in kilometres and calculated on the basis of an average consumption (18 kWh/100 km). External conditions (season, driving speed, vehicle model, etc.) may cause deviations in the actual range. When setting the charging amount, the actual state of charge of the electric vehicle battery is not read out.

The mode can be set under "**Next Trip Mode**" in the Fronius Solar.wattpilot app (see **Next Trip Mode** on page 53).

After activating the mode, charging is started briefly to calculate a charging schedule taking into account the possible charging power. If no flexible electricity tariff is activated, charging is started at the latest possible time in order to charge with a possible PV surplus and to conserve the battery of the electric vehicle. If no time is provided for the calculation of the charging schedule, charging starts immediately.

NOTE!

Internet connection required if a flexible electricity tariff is activated!

If the flexible electricity tariff is activated in Next Trip Mode and there is no connection to the electricity provider's data, the Next Trip Mode LED flashes red. Charging starts in order to reach the set charging amount.

If the charging cable is disconnected and reconnected while Next Trip Mode is activated, the calculation is repeated and the set charging amount is charged in addition to the existing charging amount. Changes to the settings of the Fronius Solar.wattpilot app result in a recalculation of the charging schedule. If the change is made during Next Trip Mode charging, the range charged up to this point is added to this.

If "**Stay in Eco Mode**" is activated, the cost optimisation settings are also taken into account in Next Trip Mode.

NOTE!

The battery of the photovoltaic system is discharged first!

If the system contains a stationary battery, the battery is discharged before mains current is drawn.

NOTE!

Orange flashing LEDs if the charging amount cannot be reached or stored!

If the set charging amount cannot be charged in the specified time or if the car cannot store the set charging amount, the LEDs flash orange.

- ▶ Reduce the charging amount or extend the charging time.
-

Example

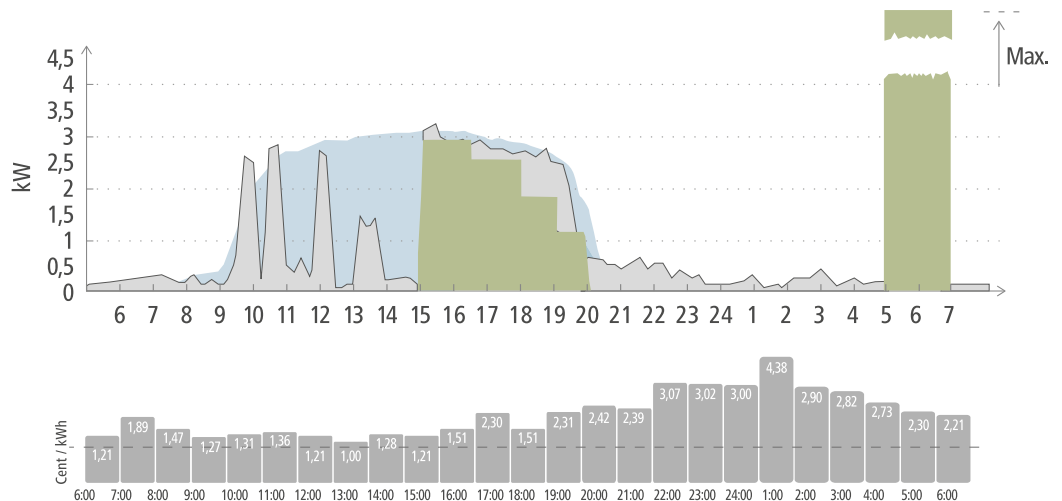

- Photovoltaic generation
- Electric vehicle
- Household consumption

The daily journey to work and back home is 50 km and must start at 08:00. In the Fronius Solar.wattpilot app, the kilometres and the departure time must be entered once under Next Trip Mode. 18 kWh is used as the basis for the calculation of 100 km. The electric vehicle is plugged in and charged at approximately 15:00. If PV surplus is available, charging is carried out with PV surplus. The remaining charging amount is guaranteed to be charged in the electric vehicle at the latest possible time. The charge is calculated in such a way that it is completed at the latest one hour before departure.

NOTE!

If there is sufficient energy in the electric vehicle, it is better to use Eco Mode.

If the electric vehicle is sufficiently charged, Eco Mode is the better choice.

- Change to Eco Mode (see [Eco Mode](#) on page 26).

Dynamic load balancing

General

Wattpilot supports dynamic load management, known as Dynamic Load Balancing. To use Dynamic Load Balancing, either a Fronius inverter with Smart Meter or a Fronius Datamanager 2.0 with Smart Meter must be installed in the complete system. In addition, the Wattpilot must be connected to the Internet.

Dynamic Load Balancing distributes power while charging with up to 3 Wattpilots, depending on their prioritisation. The power is distributed dynamically taking into account PV-surplus and the maximum reference current in the system. The prioritised vehicles are charged first.

Functional principle

With Dynamic Load Balancing, the maximum reference current can be defined for the house connection point (feed-in point). The energy produced by the PV-system and the loads are automatically taken into account. Up to 3 Wattpilots can be dynamically controlled. This dynamic control ensures the maximum possible charging current can be used.

Dynamic load balancing monitors the available current per phase (including solar power) at the house connection point (feed-in point) and dynamically distributes this to one or more Wattpilots. In this case, the Wattpilots can be supplied with the maximum available current; the maximum current is not exceeded.

NOTE!

Charge 1-phase electric vehicles evenly with multiple Wattpilots.

In the case of multiple Wattpilots, it makes sense to connect the phases differently so that the load is distributed evenly among 1-phase electric vehicles.

- ▶ Connect the phases differently.
-

The maximum reference current must be set to match the post-meter fuse.

Control system example

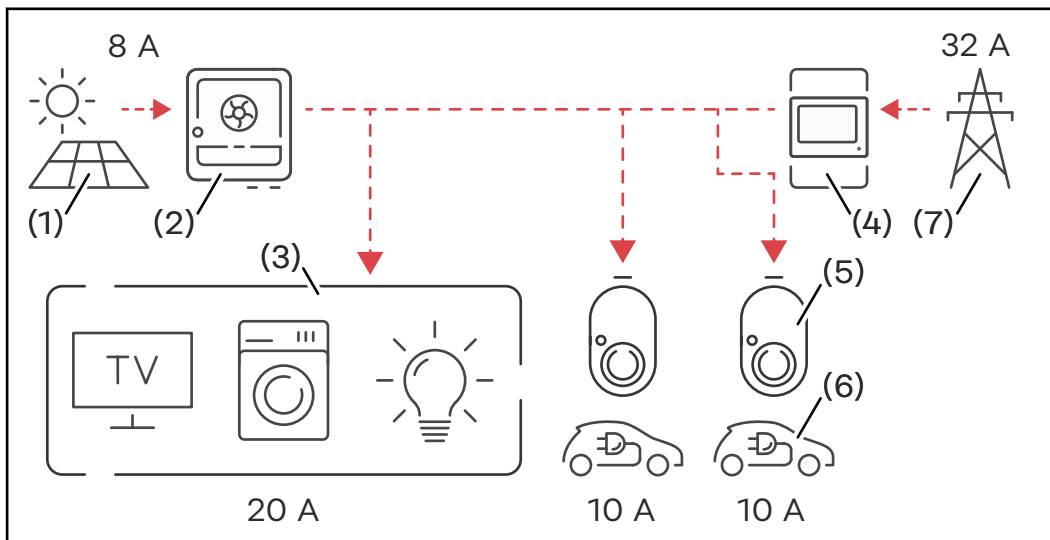

- (1) Photovoltaic system
- (2) Inverter
- (3) Loads (e.g. TV, washing machine, light)
- (4) Smart Meter
- (5) Fronius Wattpilot
- (6) Electric vehicle
- (7) Grid

In the **example of a control system**, 32 A are drawn from the public grid and 8 A are generated by the PV system, for a total of 40 A of available electricity. The household loads require 20 A, and the remaining 20 A are dynamically divided among the connected Wattpilots to enable charging of, for example, two electric vehicles with 10 A each.

NOTE!

Charging is interrupted or does not start.

If Dynamic Load Balancing is activated, charging interruptions may occur. Some electric vehicles encounter problems when starting charging again.

Priority

In the case of systems with multiple Wattpilots, charging priorities can be set. The charging stations (electric vehicles) with a higher priority are supplied with current first; charging stations with a lower priority have to wait. If there is current left over, it is shared among the lower-priority Wattpilots.

The vehicles that are to be charged first and with the maximum available current must be assigned a high priority. A low priority can be assigned to vehicles that should wait to charge until sufficient current is available.

In the case of Wattpilots with the same priority, the available current is shared equally.

Example 1

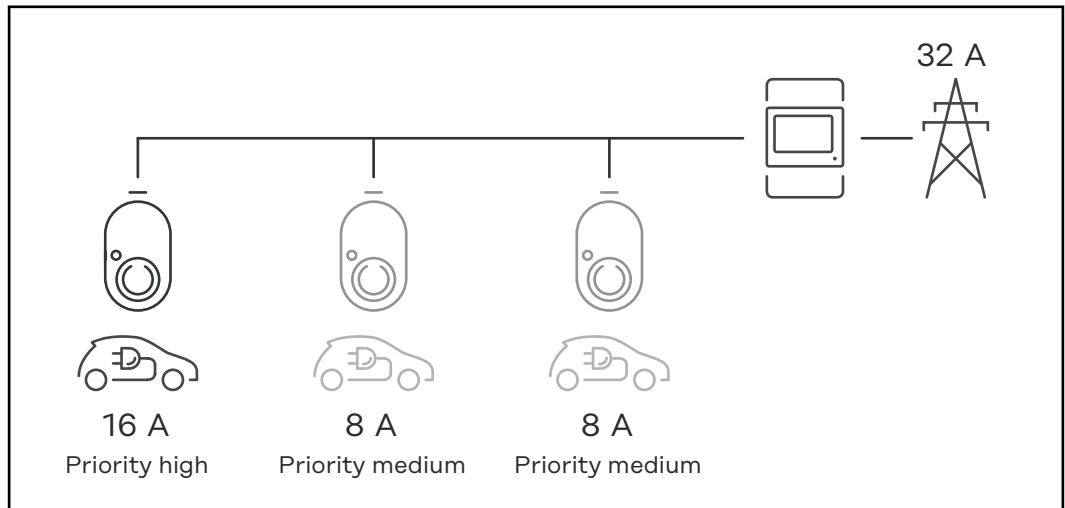

Distribution of the charging current with three Wattpilots with different priorities (one with high priority, two with medium priority).

Example 2

Distribution of the charging current with three Wattpilots (X, Y, Z) with the same priority. Each Wattpilot is assigned the minimum charging current (unless the minimum charging current is no longer available). If there is charging current left over, it is distributed wherever possible, starting with the first Wattpilot in the loop.

Wattpilot X has a minimum charging current of 6 A, Wattpilot Y 10 A and Wattpilot Z 6 A. There is 15 A of charging current to be distributed. The charging current is distributed as follows.

1. X receives 6 A, 9 A remains.
2. Y receives nothing as the minimum charging current of Y is 10 A. Y is set to 0.
3. Z receives 6 A, 3 A remains.
4. The loop starts all over again.
5. X receives 7 A, 2 A remains.
6. Y receives nothing as the charging current has already been set to 0 in the first loop.
7. Z receives 7 A, 1 A remains.
8. The loop starts all over again.
9. X receives 8 A, 0 A remains.

The 15 A charging current was distributed among the equally prioritised Wattpilots and charged. As soon as charging current is available again, the electric vehicle is charged at Wattpilot Y.

Videos

Webinars and How-to videos

The following link provides current webinars and how-to videos of the Fronius Wattpilot.

[Fronius Wattpilot YouTube Playlist](#)

Installation and commissioning

Installation location and position

Choice of location

The following criteria must be taken into account when choosing a location.

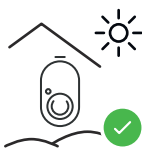

The Wattpilot is suitable for outdoor operation without direct sunlight.



The Wattpilot is suitable for operation in a well-ventilated indoor area.



Do not operate the Wattpilot in areas with increased danger as a result of ammonia gases.

The Wattpilot is suitable for operation indoors and outdoors.

For environmental conditions, see [Wattpilot Home 11 J 2.0](#) on page 71.

CAUTION!

Beware of warping of the mounting bracket on uneven surfaces.

An uneven surface can cause the mounting bracket to warp, making it impossible to attach the Wattpilot.

- ▶ Select a suitable location on an even surface.

Installation position



The Wattpilot is designed to be installed vertically on a vertical, level wall.



- Do not install the Wattpilot horizontally.
- Do not install the Wattpilot on a sloping surface.
- Do not install the Wattpilot on a sloping surface with the connection facing down.

CAUTION!

Danger due to heat generation on the device!

The build-up of heat can lead to lasting damage and even fire.

- ▶ Observe the correct installation position.
- ▶ Never cover the device during charging.
- ▶ Unwind the cable completely from a cable drum.

NOTE!

The type 2 plug is not waterproof.

Water can penetrate when the Wattpilot is mounted horizontally.

- ▶ Mount the Wattpilot vertically.
-

Installation

Mounting the Wattpilot on the wall

When mounting the mounting bracket, ensure that it is not warped or deformed. The following illustrations may differ slightly from the actual product; the Wattpilot Home 11 J 2.0 / Home 22 J 2.0 does not have a mains plug.

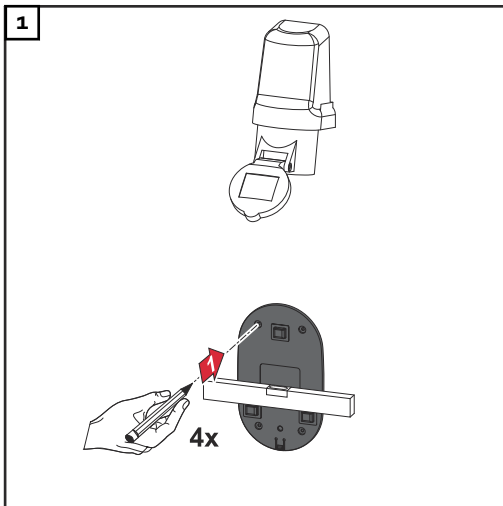

Mark the drill holes 4 times.

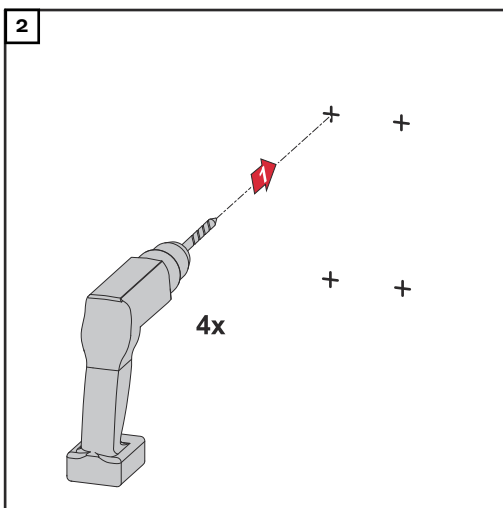

Drill 4 holes.

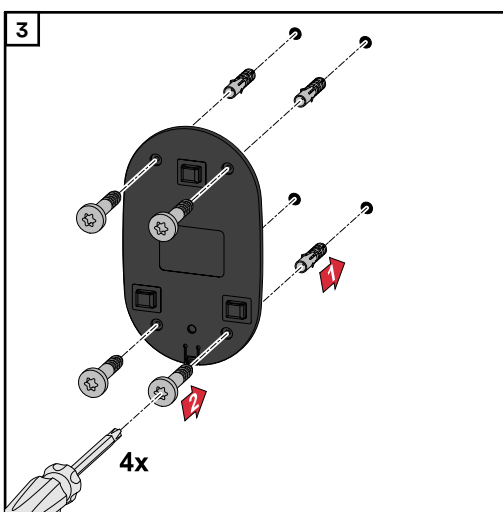

Place dowels in the holes and fasten the mounting bracket with screws.

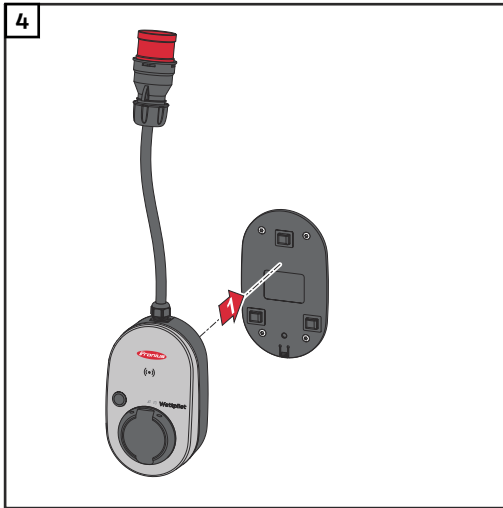

Hang the Wattpilot in the mounting bracket.

NOTE!

To protect the Wattpilot from contact, it must be mounted at least 140 cm above the ground.

- The minimum height of 140 cm must be observed in Sweden.

Mounting the anti-theft protection

The mounting material and the padlock are not included. Use appropriate fastening materials depending on the substrate. The installer is responsible for selecting the right type of fixing.

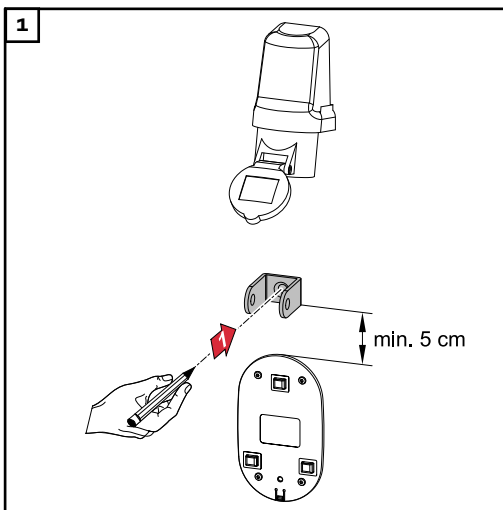

Mount the anti-theft protection at least 5 cm above the mounting bracket.

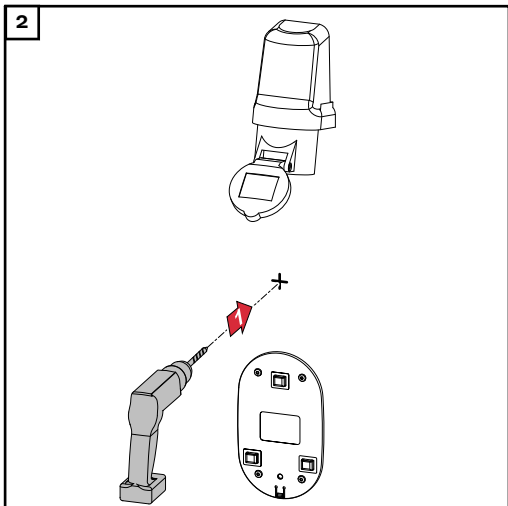

Drill a hole with a suitable drill bit.

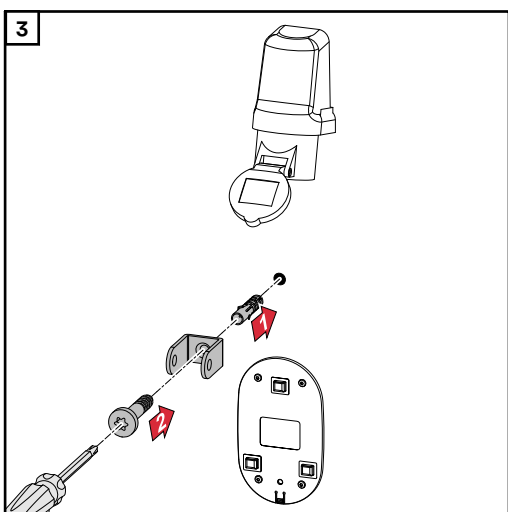

Mount the anti-theft protection using suitable mounting material.

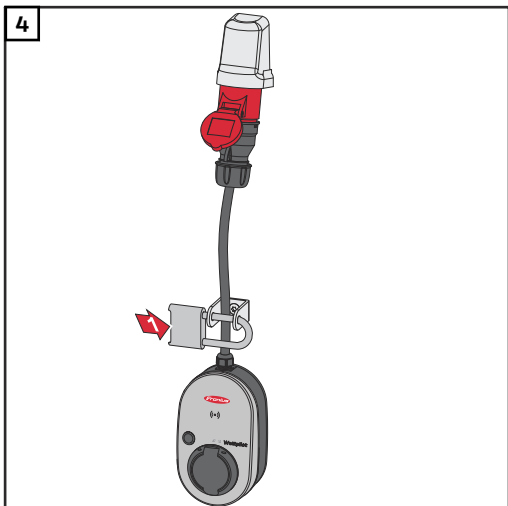

Secure the Wattpilot with a padlock.

Connecting the Wattlepilot

General information

CAUTION!

Installation and commissioning may only be performed by a qualified electrician.

Requirements for the qualification of electricians - knowledge and observation of the 5 safety rules for working on electrical systems.

- ▶ Disconnect.
- ▶ Ensure the device cannot be switched back on.
- ▶ Ensure the system is no longer live.
- ▶ Carry out earthing and short-circuiting.
- ▶ Cover nearby live components or make them inaccessible.

NOTE!

Check with the grid operator whether there is a duty to inform in the country of destination and, if necessary, report the Wattlepilot to the grid operator.

Installing the Wattlepilot Home

When installing the Wattlepilot Home 11 J 2.0 or Home 22 J 2.0, the mains cable must be installed by a qualified person in accordance with national standards. The fuse protection for the mains lead must be dimensioned in accordance with the device technical data.

WARNING!

Danger from mains voltage!

An electric shock can be fatal.

- ▶ Always make sure the circuit is disconnected and de-energised before carrying out any connection work.
- ▶ Have the connection work performed by an authorised electrical engineer.
- ▶ Observe the national standards.

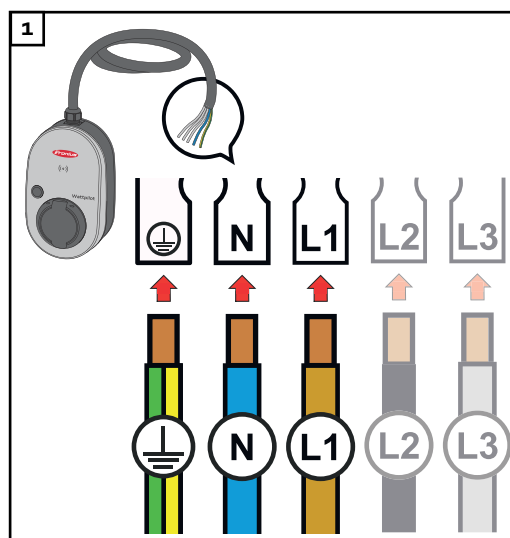

Have the 5-pin mains cable connected by an authorised electrician in accordance with national standards and safety rules. Depending on the available mains supply type, opt for a 1- or 3-phase connection.

NOTE!**For 1-phase operation, use phase L1.**

- ▶ To supply power to the Wattlepilot, phase L1 must be connected. The unused phases L2 and L3 must be isolated (contact protection)!

Backup power mode**NOTE!****It is advisable to connect the Wattlepilot outside the backup power loads of a photovoltaic system!**

If the charging current per phase cannot be covered by the backup power, connect the Wattlepilot outside the backup power loads.

If the Wattlepilot is connected in the backup power circuit of a photovoltaic system and the total current of one phase is exceeded as a result, the inverter switches off the backup power. The electric vehicle must be unplugged and the backup power acknowledged (see inverter Operating Instructions).

IMPORTANT!

Check whether the electric vehicle allows charging at 53 Hz.

Commissioning

Start up the permanently installed Wattlepilot Home 11 J 2.0 / Home 22 J 2.0 from step 2.

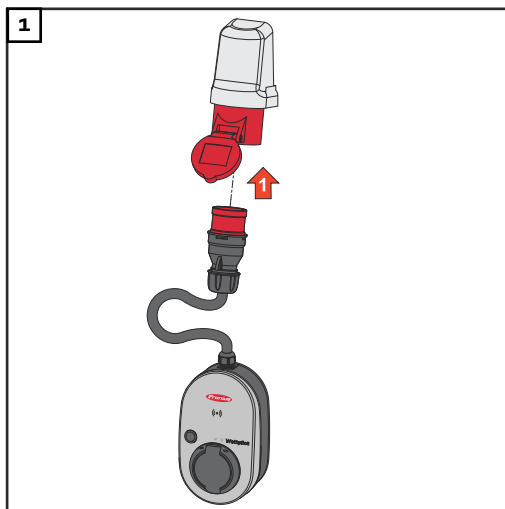

Connect the CEE plug to a suitable socket directly or with a suitable adapter.

NOTE!

The LEDs light up in the rainbow colours during an initial self-test. Afterwards, the number of LEDs corresponding to the set charging current light up blue.

- 2 Set the desired charging current by pressing the pushbutton. (See [Pushbutton functions](#) on page 15).

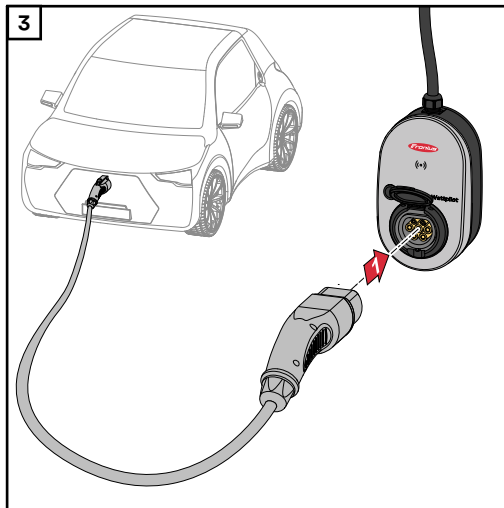

Connect a Type 2 to Type 2/Type 1 charging cable to the Wattpilot and the car.

During a test, all LEDs light up yellow.

The start of the charging process is indicated by the switching of the LEDs and started with a clicking sound from the Wattpilot.

For more information on LED status indicators, see chapter [LED status indicator](#) on page 17.

The car is charged.

Stopping charging

When the vehicle battery is fully charged, the vehicle stops charging.

Unlocking the charging cable

- 1 Disconnect the charging cable from the vehicle.
- 2 Disconnect the charging cable from the Wattpilot.

NOTE!

The charging cable remains locked to the Wattpilot by default (anti-theft protection). This can be changed in the app (see chapter [Cable release](#) on page 57).

Aborting the charging process prematurely

- In the vehicle via the "cable release" function
- In the app by clicking on "Stop" (see chapter [Homepage](#) on page 51).

NOTE!

The way in which the cable is released can be configured in the app.

If the power supply is interrupted, the charging cable remains locked in the Wattpilot for reasons of theft protection. The cable release can be activated in the app under "Unlock in case of power failure".

- ▶ Restore the power supply to the Wattpilot to unlock the charging cable.
- ▶ Configure the cable release in the app.

Data communication with the inverter

Charging with PV surplus (see [PV surplus](#) on page 22) is possible with a supported Fronius inverter to which a primary Fronius Smart Meter is connected. As soon as an inverter is in the network, the Wattpilot automatically connects with the first inverter that is found.

Another inverter can be coupled via the Fronius Solar.wattpilot app (see [Cost optimisation](#) on page 53).

Prerequisites

- The inverter is supported and has a suitable data interface (see [Suitable inverters](#) on page 13).
- The Wattpilot and the inverter are in the same network.
- A primary Fronius Smart Meter at the feed-in point must be connected to the inverter. If there are several inverters with primary Fronius Smart Meters in the network, only one of them may be coupled.

Fronius Solar.wattpilot app

Overview

General

The Fronius Solar.wattpilot app can be used to start up, configure, operate, visualise and update the Wattpilot. The app is available for Android™ and iOS®.

You can access the Wattpilot via the app as follows:

- Directly (see [Setting up the WLAN](#) on page 50)
 - Via Internet (see [Setting up the WLAN](#) on page 50)
-

Download

The Fronius Solar.wattpilot app is available on the following platforms.



Connecting via WLAN

Launching the app

- 1 Open the Fronius Solar.wattpilot app on the end device and follow the Setup wizard.
- 2 Read and accept the terms of use.
- 3 Click on "Connect".

NOTE!

Access for the Fronius Solar.wattpilot app must be allowed for end devices with an iOS operating system.
iOS settings > Privacy > Local network > Fronius Solar.wattpilot > Allow access to local network

Setting up a hot spot

The Wattpilot permanently opens a hot spot.

- 1 Scan the QR code on the reset card or connect the end device to the WLAN hot spot. The password is located on the reset card of the Wattpilot.
- 2 Follow the further instructions in the app.

NOTE!

The selected WLAN of the Wattpilot must remain connected despite the absence of an Internet connection for end devices with an Android operating system.

Setting up the WLAN

- 1 Select WLAN and enter the password.

NOTE!

It can take up to 1 minute to establish the connection!

If the signal strength is low, a WLAN repeater must be installed, for example.

- 2 Follow the further instructions in the app.
-

Adding a Wattpilot

New or connected Wattpilot devices can be added in the Fronius Solar.wattpilot app.

- 1 Click on the "+" symbol.
- 2 Click on "Add" for the connected Wattpilot.
- 3 Follow the further instructions in the app.
 - See [Setting up a hot spot](#) on page 50.
 - See [Setting up the WLAN](#) on page 50.

Charging

Homepage

The figure below shows the "Charging" homepage of the Fronius Solar.wattpilot app.

The screenshot shows the 'Charging' homepage of the Fronius Solar.wattpilot app. The interface includes a top header with the user ID 'Wattpilot_10000001' and a '+' icon. Below the header is the title 'Charging' and three tabs: 'Power', 'Details', and 'Forecast'. The main content area features a large circular gauge showing a charging power of 10,4 kW, with a stop time of 04:39:35. Below the gauge are three circular buttons for 'Mode', '16 A Current', and '18:00'. A 'Status' section displays 'Charging with 10,40 kW'. A 'Range' section shows 'Charging 57,78 km per hour', 'Range ~47,22 km (8,50 kWh)', and 'Total ~9511,83 km (1712,13 kWh)'. At the bottom is a navigation bar with 'Charging', 'Settings', and 'Internet' icons. Red brackets and numbers (1) through (5) are overlaid on the image to indicate specific UI elements.

(1) Touch the app icon and go to the "Select Wattpilot" page. Add a new Wattpilot by pressing the "+" icon.

(2) Views in the main window:

- "Power"
- "Details"
- "Forecast"

(3) **Power:**
The current charging current and the charging time are displayed.

- Touch circle: Charging is started/stopped
- Touch buttons below: Call up "Mode", "Charging current" or "Next Trip Mode"

(4) Details of the current charging process are displayed under "Status" and "Range".

(5) The following pages can be called up:

- "Charging"
- "Settings"
- "Internet"

Energy per user

Under "**Range**", a list showing the consumption of the registered ID chips can be called up via "**Energy per user**". By entering "Total", the list can be downloaded as a *.csv file. The following data is displayed in the file:

- **Session number:** Sequential number. A session is the period of time between connecting and disconnecting the charging cable.
- **Session identifier:** Unique identification number.
- **ID chip:** Information about the registered ID chip. No entry if loaded without ID chip.
- **ECO operating mode [%]:** Proportion of the charged energy from Eco Mode as a percentage.
- **Next Trip operating mode [%]:** Proportion of the charged energy from Next Trip Mode as a percentage.
- **Start:** Start date and time from which the charging cable is connected.
- **End:** End date and time when the charging cable is disconnected.
- **Total duration:** Period of time during which the Wattpilot is in use.
- **Duration of active current flow:** Period of time during which energy was being charged into the vehicle.
- **Max. power [kW]:** Maximum power in kilowatts reached during charging.
- **Max. current [A]:** Maximum current in amperes reached during charging.
- **Energy [kWh]:** Indicates the charged energy in kilowatt hours.
- **PV energy [kWh]:** Indicates the charged energy in kilowatt hours provided by PV surplus.
- **Battery energy [kWh]:** Proportion of the charged energy in kilowatt hours provided by a stationary energy storage device.
- **Meter reading start [kWh]:** Indicates the charged energy in kilowatt hours at the start of the charge.
- **Meter reading end [kWh]:** Indicates the charged energy in kilowatt hours at the end of the charge.

Current level

Five current levels can be set, from "gentle" to "rapid", by pressing the pushbutton on the Wattpilot. Press the pushbutton for at least 2 seconds (see chapter [Pushbutton functions](#) on page 15).

The desired levels can be adjusted by clicking in the respective field.

NOTE!

If charging in an unknown infrastructure, always charge with the lowest charging current (e.g. 6 A or 10 A).

NOTE!

A slow charge with a low amperage is gentler on the battery of the vehicle. This can extend the service life of the battery.

Next Trip Mode

Charging is carried out as cheaply as possible using surplus PV current (see [PV surplus](#) on page 22) and a flexible electricity tariff (see [Flexible electricity tariff](#) on page 25).

- 1 Under "Settings", click on the "Next Trip Mode" button.
- 2 Specify the "Minimum amount of charging" in kilometres (km) or kilowatt-hours (kWh).
 - 100 km correspond to 18 kWh as standard. The actual consumption over 100 km varies from vehicle to vehicle and can be adjusted under "Consumption over 100 km".
- 3 Enter the time by which charging must be complete.

Activating "Next Trip Mode"

- Directly on the Wattpilot by pressing the pushbutton (see [Pushbutton functions](#) on page 15).
- In the app, under "Charging", click on the "Mode" button and activate "Next Trip Mode".

Activating "Eco Mode after Next Trip Mode"

After reaching the set range, the Wattpilot switches from **Next Trip Mode** to **Eco Mode**. Charging continues with the **Eco Mode** settings.

Cost optimisation

Under "Cost optimisation", the consideration of the electricity tariff (see [Flexible electricity tariff](#) on page 25) and the use of PV surplus (see [PV surplus](#) on page 22) can be activated. The settings listed below can also be customised.

Use Lumina Strom / aWattar

Activation or deactivation of flexible electricity tariffs.

Eco Mode price limit

When a flexible electricity tariff is activated in Eco Mode, charging does not start until the set electricity price is below this value. If the electricity price is above this value, charging does not take place.

NOTE!

In Next Trip Mode, it is not this value that is taken into account but the most favourable charging times in the available time period.

Use PV surplus

Activate or deactivate. If "Use PV surplus" is activated, the Wattpilot uses the surplus PV energy for charging.

Inverter

Selection of a coupled inverter.

PV battery threshold

If a battery is installed in the photovoltaic system, a limit value can be set here. Below the set value, the battery is charged as a priority. Above this value, the energy is charged into the vehicle instead of into the stationary battery. The SOC (state of charge) of the battery may still slowly increase.

Ohmpilot threshold - optional

If a Fronius Ohmpilot with temperature sensor is installed in the photovoltaic system, a limit value for the temperature can be set here. Below the set value, the available energy is prioritised for heating. Above this value, the vehicle is charged instead of heating with the Ohmpilot. The temperature may still slowly increase.

PV surplus- advanced settings

In the advanced settings, a **start-up power level** can be set from which the PV energy is used for charging. Vehicles require a certain minimum power in order to charge.

- **Start-up power level:** If "0" is set, the Wattpilot will start charging even if no PV surplus is available.
- **Zero feed-in:** No PV current is fed into the grid. If zero feed-in is activated in the inverter, it must also be activated in the Wattpilot.

Deviations may occur when using PV surplus, as vehicles are regulated in stages. The following settings can be made under **Control response**:

- **Prefer from grid:** The Wattpilot prioritises consumption over feed-in from the grid.
- **Default:** The Wattpilot enables both consumption and feed-in.
- **Prefer to grid:** The Wattpilot prioritises feed-in over consumption from the grid.

NOTE!

If zero feed-in is activated, the prioritisation of system components cannot be guaranteed. PV optimisation control may be restricted.

Car- advanced settings

With intelligent charging, the charging process can be interrupted or the charging current reduced in order to meet certain charging conditions. Specify car-specific settings for smooth smart charging.

- **Choose car:** For activating the optimised standard settings of different vehicle models.
- **Minimum current:** Some cars will not resume charging after an interruption. To prevent an interruption, the **minimum charging current** can be set.
- **Forced charging interval:** In the case of cost-optimised charging, the Wattpilot interrupts the charging process if the electricity price is too high. Some cars will not tolerate interruptions and will not continue charging after prolonged interruptions to the charging process. In this case, the charging process must be started regularly for a short time.
- **Allow charging pause:** Some cars will not resume charging after an interruption. Charging interruptions are prevented if this option is deactivated.
- **Simulate unplugging:** Some cars need to be disconnected for a while if there has been an interruption during cost-optimised charging. This function simulates a disconnection before charging continues.
- **Charging pause:** Some cars require a certain amount of time after an interruption to charging before they can start charging again.
- **Minimum charging time:** Set the minimum time for which the car must be charged after charging starts.
- **Choose phase switch:**
 - **Automatic:** A power level can be set, from which 3-phase charging takes place. If "0" is set, the Wattpilot immediately starts 3-phase charging.
 - **Only 1-phase:** There is 1 phase available for charging.
 - **Only 3-phase:** There are 3 phases available for charging.
- **3-phase power level:** Set a power level that must be reached by the photovoltaic system before the Wattpilot switches from 1-phase to 3-phase charging. If the available power is greater than the set value, the Wattpilot immediately activates 3-phase charging. Automatic switching can be deactivated in the car settings.
- **Phase switch delay:** Phase switching is performed when the "3-phase power level" is permanently exceeded or undercut during this period.
- **Phase switch interval:** Minimum time between phase switching.

NOTE!

If a vehicle to be charged is not listed, no specific charging behaviour is known. All defaults can be customised.

- ▶ Select the standard charging behaviour.

Charging timer

The "**Charging timer**" setting limits charging to specific times. A start and end time must be specified for this. Several time windows can be set. The following can be set:

- The time (start and end time) and
- The days of the week.

NOTE!

Verhalten bei aktiviertem Eco Mode or Next Trip Mode:

If charging is not allowed by the charging timer for a certain period of time, Eco Mode and Next Trip Mode are also blocked for this period.

If the charging timer does allow charging in a certain period of time but the settings for Eco Mode or Next Trip Mode are not met, charging will not occur.

Load Balancing

Dynamic Load Balancing can be selected and set under "Load Balancing".

Load balancing off

With this setting, no load balancing is carried out by the Wattpilot.

Dynamic load balancing

For general information on Dynamic Load Balancing, see [Dynamic load balancing](#) on page 30. Dynamic Load Balancing monitors the current at the reference point. It dynamically limits the current for up to three Wattpilots to ensure that the maximum reference current is not exceeded. The following settings can be made:

- **Maximum reference current**
Set the maximum reference current for the power connection, which must not be exceeded.
- **Phase assignment**
The smart meter monitors each phase. For load balancing to work properly, the phase assignment of the Wattpilot must be set in relation to the smart meter. This causes the correct Wattpilot to be regulated back when the current of a phase is exceeded.
- **Priority**
In the case of systems with multiple Wattpilots, charging priorities can be set (see [Priority](#)).
- **Fallback mode**
If there is no connection to the server, the Wattpilot limits the charging current back to the set value in fallback mode. This ensures that the infrastructure is not overloaded.
- **Overview**
Display of all Wattpilots in load balancing.

Name	Change the name of the paired Wattpilot.
-------------	--

Brightness	Set LED brightness values. By activating " Switch off LEDs after 10 s in standby ", the LEDs on the device are switched off after 10 seconds in standby.
-------------------	---

LED colours	Customise LED colours.
--------------------	------------------------

Time zone	Set the time zone. Activating " Automatic summer time changeover " automatically sets the summer and winter time.
------------------	--

Access management	<p>In the "Access management" menu, it is possible to set whether charging is started automatically or after confirmation. In addition, mode selection and current level selection can be set using the pushbutton on the device.</p> <p>Authentication</p> <ul style="list-style-type: none">- Open: The charging process is started automatically after connecting the cables.- Authentication required: Charging will only start after confirming in the app or scanning the supplied ID chip.
--------------------------	--

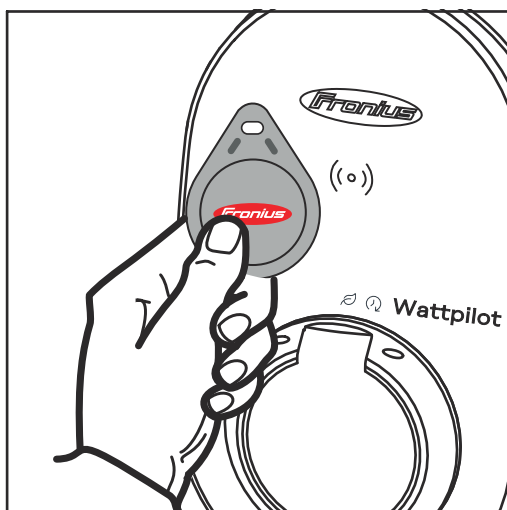

Scan the ID chip

- 1 Hold the ID chip in front of the card reader on the Wattpilot.
- 2 Five LEDs light up green. Charging starts.

Lock mode selection

Set whether the pushbutton on the Wattpilot should be locked. Locking the pushbutton prevents accidental changing of the mode.

- **Always locked:** Changing the mode is only possible via the connected Fronius Solar.wattpilot app.
- **Locked when car is connected:** Changing the mode by pressing the pushbutton is possible with the vehicle disconnected.
- **Never locked:** Standard setting.

Lock current level selection

Set whether the pushbutton on the Wattpilot should be locked. Locking the pushbutton prevents accidental changing of the current level.

- **Always locked:** Changing the current level is only possible via the connected Fronius Solar.wattpilot app.
- **Locked when car is connected:** Changing the current level by pressing the pushbutton is possible with the vehicle disconnected.
- **Never locked:** Standard setting.

Cable release

Standard mode

The charging cable at the charging station remains locked after completion of the charging process until the charging cable is disconnected from the vehicle (anti-theft protection).

Auto-unlock

The charging cable is only locked during charging.

Always locked

The charging cable on the Wattpilot is always locked. Switch to standard mode to unlock.

Unlock in case of power failure

The charging cable is unlocked in the event of a power failure. By default, the charging cable remains locked in the event of a power failure for reasons of theft protection. To unlock the charging cable, the Wattpilot must be supplied with power again.

Earthing test

Activation or deactivation of the earthing test. It is necessary to deactivate the earthing test in insulated grids in some countries (e.g. Norway).

ID chips

Up to 10 ID chips can be used. The ID chip is used for authentication and for recording user-specific charging amounts.

NOTE!

One ID chip can be taught in for several Fronius Wattpilot devices.

Learn ID chip

- 1 Hold the **ID chip** in front of the card reader of the Wattpilot.
- 2 Click on "Teach in **ID chip**" in the app.

Renaming an ID chip

- 1 Tap the corresponding entry.
- 2 Enter the desired name and tap "Save".

NOTE!

The **ID chips** and the charging amount remain stored in the event of a reset.

Password

The password protects against unauthorised access to the Wattpilot.

Password guidelines

- At least 10 characters
- At least three of the following four strings: Upper case letters, lower case letters, numbers, special characters
- No umlauts (ä, ö, etc.)
- No paragraph sign (§)

Technician password

If the technician password is activated, it is required to access "Grid settings".

NOTE!

If the password has been forgotten, contact the support team.

Grid settings

Proceed as follows to call up the "**Grid settings**".

Technician password

- 1 Click on "**Grid settings**".
- 2 Enter the "**Technician password**".
- 3 Click "**OK**".

Choose country

Different charging conditions are allowed depending on the country. In this selection, all known default settings for the respective country are stored and can be selected directly.

Max. charging current

This setting is used to adjust the maximum charging current of the Wattpilot. Higher charging currents can no longer be selected.

NOTE!

PV optimisation works best when the maximum charging current is set as high as the maximum allowed in the respective country. To start charging, the value must be higher than the minimum current in the vehicle settings.

Max. 1-phase charging current

In some countries, charging via household sockets is only permitted up to a certain amperage. The Wattpilot automatically detects that it is a 1-phase socket and limits the current to the set value.

NOTE!

For camping sockets, there is no need to set a special limit for the maximum 1-phase charging current.

Internet

Connection

The following connection options can be configured in the "Internet" menu:

- WLAN
 - Configured networks and available networks are listed. More networks can be added.
 - For further information see chapter [Connecting via WLAN](#) on page 50.
- Hot spot password
 - Set the hot spot password.
 - For further information see chapter [Connecting via WLAN](#) on page 50.
- Advanced settings
 - Activate or deactivate "Allow Internet connection". If "Allow Internet connection" is deactivated, functions such as the flexible electricity tariff, time synchronisation or app connection to the Internet are not possible.
- OCPP
 - Configuration of the Open Charge Point Protocol (free charging point communication standard).
 - For further information see chapter [OCPP](#) on page 60.

OCPP

The charging point communication standard OCPP (Open Charge Point Protocol) is a universal communication protocol for charging infrastructures. It enables communication between the Wattpilot and a management system, via which, for example, load distribution of an infrastructure or billing can be carried out. It can be set up via a remote server provider or locally.

Activate OCPP

Activation or deactivation of OCPP.

Address

The address of the OCPP server must be provided by the provider and entered in the OCPP menu of the app.

Phase assignment

Implement settings for how the phases of the Wattpilot are assigned compared to a Smart Meter. This is necessary, for example, to ensure that load balancing functions correctly.

Status

The following status indicators are available:

- Not connected: OCPP is not activated and not connected to a management system.
- Started: OCPP is activated but there is no successful connection to the management system yet.
- Connected: OCPP is activated and there is a connection to the management system but it has not yet been accepted.
- Connected and accepted: OCPP is activated and there is a connection to the management system, the connection has been accepted.

Custom certificate

Possibility to enter a self-created certificate for OCPP.

Restart

After confirming the restart, the Wattpilot is restarted; the most recent settings remain saved.

Firmware update The current firmware of the Wattpilot is loaded via the Internet. The "Internet" menu shows which firmware version is installed and whether an update is available.

Firmware update

- 1 Click on "Update available".
- 2 Click on "Update".
- 3 After a firmware update, check whether the Fronius Solar.wattpilot app also needs to be updated.

The Fronius Solar.wattpilot app can be updated via the respective platform (Google Play Store, App Store).

Appendix

Residual current detection

The tripping characteristics of the residual current detection are as follows.

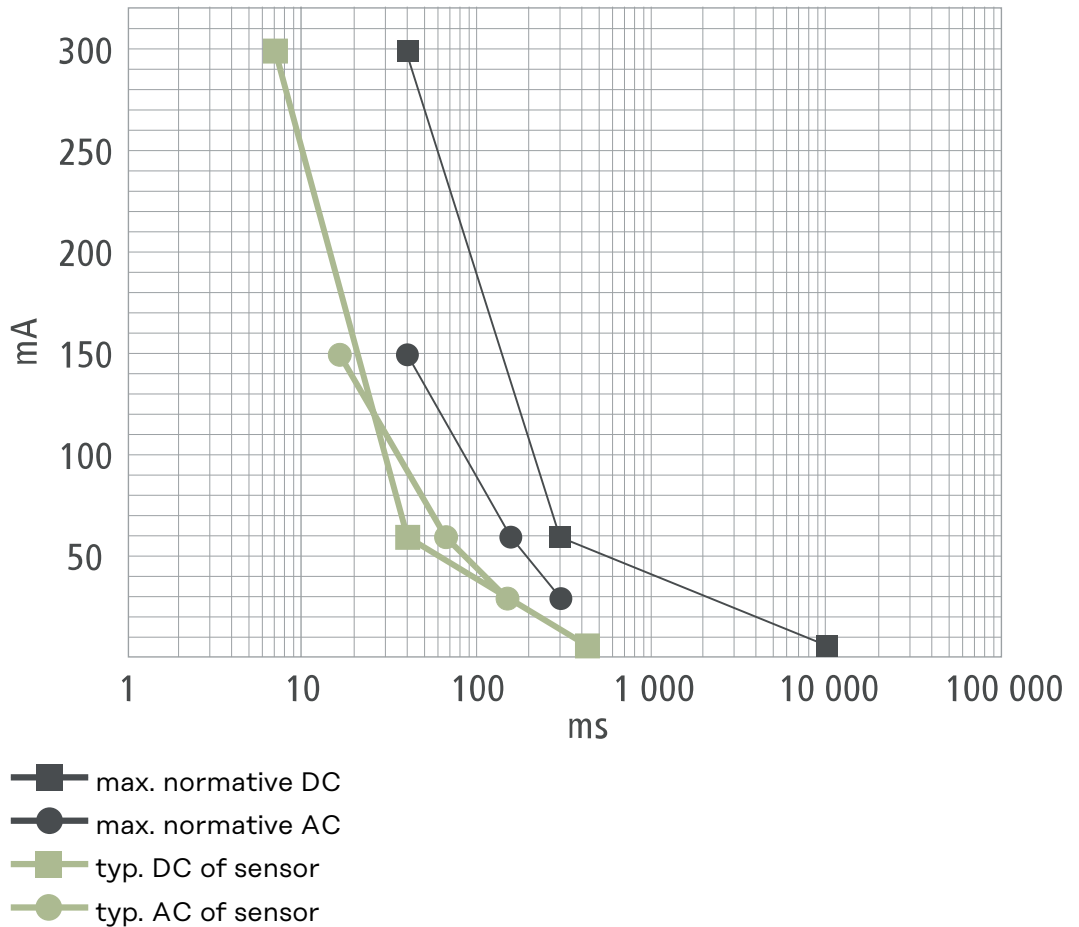

Safety functions

- RFID access control (ID chip, reset card)
- Theft-proof charging socket lock
- Cable protection (lock not included)
- Residual current device with DC detection, 20 mA_{AC}, 6 mA_{DC}
- Phase and voltage testing of the input voltage
- Auxiliary contact on the relays for checking the switching function
- Earthing detection (can be switched off, Norway mode)
- Current sensor, 3-phase
- Adapter recognition with automatic reduction to 16 A (Wattpilot Go 22 J 2.0)
- Temperature monitoring

Standard settings

The Wattpilot works with the following standard settings during start-up, without making any further settings in the Fronius Solar.wattpilot app. The standard settings can be restored with the reset card.

Charging mode	Go 11 J 2.0 / Home 11 J 2.0	Go 22 J 2.0 / Go 22 J 2.0 AUS / Home 22 J 2.0
Eco Mode	Off	
Next Trip Mode	Off	

Current level	Go 11 J 2.0 / Home 11 J 2.0	Go 22 J 2.0 / Go 22 J 2.0 AUS / Home 22 J 2.0
Level 1 (gentle)	6 A	10 A
Level 2	10 A	16 A
Level 3	12 A	20 A
Level 4	14 A	24 A
Level 5 (rapid)	16 A	32 A

Next Trip Mode	Go 11 J 2.0 / Home 11 J 2.0	Go 22 J 2.0 / Go 22 J 2.0 AUS / Home 22 J 2.0
Minimum range [km] or [kWh]	100 [km] [18.00 kWh]	
Until [time]	06:00	
Eco Mode after Next Trip Mode	On	
Consumption over 100 km	18 [kWh]	

Cost optimisation	Go 11 J 2.0 / Home 11 J 2.0	Go 22 J 2.0 / Go 22 J 2.0 AUS / Home 22 J 2.0
Use Lumina Strom / aWattar	Off	
Country	Germany	
Eco Mode price limit	3 cents	
Use PV surplus	On	
Inverter	First found, otherwise empty	
PV battery limit value	20 %	
Ohmpilot limit value	20 °C	
PV surplus	For advanced settings, see the following table	
Car	For advanced settings, see the following table	

PV surplus	Go 11 J 2.0 / Home 11 J 2.0	Go 22 J 2.0 / Go 22 J 2.0 AUS / Home 22 J 2.0
Start-up power level	1.40 kW	
Zero feed-in	Off	
Control response	Standard	

Car	Go 11 J 2.0 / Home 11 J 2.0	Go 22 J 2.0 / Go 22 J 2.0 AUS / Home 22 J 2.0
Choose car	Standard charging behaviour	
Minimum current	6 A	
Forced charging interval	0 min	
Allow charging pause	On	
Simulate unplugging	Off	
Charging pause	0 min	
Minimum charging time	5 min	
Choose phase switch	Automatic	
3-phase power level	4.20 kW	
Phase switch delay	2 min	
Phase switch interval	10 min	
Charging timer	Charging timer deactivated	

Brightness	Go 11 J 2.0 / Home 11 J 2.0	Go 22 J 2.0 / Go 22 J 2.0 AUS / Home 22 J 2.0
Brightness	Max.	
Switch off LEDs after 10 s in standby	Off	

LED colours	Go 11 J 2.0 / Home 11 J 2.0	Go 22 J 2.0 / Go 22 J 2.0 AUS / Home 22 J 2.0
Ready	R = 0, G = 0, B = 255	
Charging	R = 0, G = 255, B = 255	
Done	R = 0, G = 255, B = 0	

Time zone	Go 11 J 2.0 / Home 11 J 2.0	Go 22 J 2.0 / Go 22 J 2.0 AUS / Home 22 J 2.0
Time zone	GMT+1:00 ECT European Central Time	
Automatic summer time changeover	On	
Local time	Automatic	

Access management	Go 11 J 2.0 / Home 11 J 2.0	Go 22 J 2.0 / Go 22 J 2.0 AUS / Home 22 J 2.0
Authentication	Open	
Lock mode selection	Never locked	
Current level selection locked	Never locked	

Cable release	Go 11 J 2.0 / Home 11 J 2.0	Go 22 J 2.0 / Go 22 J 2.0 AUS / Home 22 J 2.0
Cable release	Standard mode	
Unlock in case of power failure	Off	

Earthing control	Go 11 J 2.0 / Home 11 J 2.0	Go 22 J 2.0 / Go 22 J 2.0 AUS / Home 22 J 2.0
Earthing control	Activated	

Additional settings	Go 11 J 2.0 / Home 11 J 2.0	Go 22 J 2.0 / Go 22 J 2.0 AUS / Home 22 J 2.0
Earthing control	Activated	
ID chip	Supplied ID chip is taught in	
Allow Internet connection	On	

Technical data

Wattpi- lot Go 11 J 2.0

Fronius Wattpilot – technical data	Go 11 J 2.0
Max. charging power	11 kW
Mains supply types	TT / TN / IT
Mains connection	CEE plug, red, 16 A, 5-pin incl. Neutral conductor
Nominal voltage	230 and 240 V (1-phase) / 400 and 415 V (3-phase)
Nominal current (configurable)	6 - 16 A 1-phase or 3-phase
Grid frequency	50 Hz
Power consumption in standby	1.9 W (LED dark), 4.2 W (LED bright)
Charging socket	Type 2 infrastructure socket with mechanical lock
Residual current device	20 mA _{AC} , 6 mA _{DC}
Supply line cable cross-section	Min. 2.5 mm ²
RFID (radio frequency identification)	13.56 MHz
WLAN	IEEE 802.11b/g/n 2.4 GHz
Supported safety standards	WEP, WPA, WPA2, WPA3
Safety class	IP 65
Impact resistance	IK08
Dimensions (width x height x depth)	155 x 287 x 109 mm
Weight	2 kg
Use	Indoors and outdoors No direct sunlight
Installation type	Suspended
Ambient temperature	-25 to +40 °C
Average ambient temperature over 24 hours	Max. 35 °C
Humidity	5 - 95%
Height above sea level	0 - 2,000 m

Wattpi- lot Go 22 J 2.0

Fronius Wattpilot – technical data	Go 22 J 2.0
Max. charging power	22 kW
Mains supply types	TT / TN / IT
Mains connection	CEE plug, red, 32 A, 5-pin incl. Neutral conductor

Fronius Wattpilot – technical data	Go 22 J 2.0
Nominal voltage	230 and 240 V (1-phase) / 400 and 415 V (3-phase)
Nominal current (configurable)	6 - 32 A 1-phase or 3-phase
Grid frequency	50 Hz
Power consumption in standby	1.9 W (LED dark), 4.2 W (LED bright)
Charging socket	Type 2 infrastructure socket with mechanical lock
Residual current device	20 mA _{AC} , 6 mA _{DC}
Supply line cable cross-section	Min. 6 mm ²
RFID (radio frequency identification)	13.56 MHz
WLAN	IEEE 802.11b/g/n 2.4 GHz
Supported safety standards	WEP, WPA, WPA2, WPA3
Safety class	IP 65
Impact resistance	IK08
Dimensions (width x height x depth)	155 x 287 x 109 mm
Weight	2 kg
Use	Indoors and outdoors No direct sunlight
Installation type	Suspended
Ambient temperature	-25 to +40 °C
Average ambient temperature over 24 hours	Max. 35 °C
Humidity	5 - 95%
Height above sea level	0 - 2,000 m

Wattpilot Go 22 J 2.0 AUS

Fronius Wattpilot – technical data	Go 22 J 2.0 AUS
Max. charging power	22 kW
Mains supply types	TT / TN / IT
Mains connection	3-phase plug 32 A (AU), incl. neutral conductor
Nominal voltage	230 and 240 V (1-phase) / 400 and 415 V (3-phase)
Nominal current (configurable)	6 - 32 A 1-phase or 3-phase
Grid frequency	50 Hz
Power consumption in standby	1.9 W (LED dark), 4.2 W (LED bright)
Charging socket	Type 2 infrastructure socket with mechanical lock

Fronius Wattpilot – technical data	Go 22 J 2.0 AUS
Residual current device	20 mA _{AC} , 6 mA _{DC}
Supply line cable cross-section	Min. 6 mm ²
RFID (radio frequency identification)	13.56 MHz
WLAN	IEEE 802.11b/g/n 2.4 GHz
Supported safety standards	WEP, WPA, WPA2, WPA3
Safety class	IP 65
Impact resistance	IK08
Dimensions (width x height x depth)	155 x 287 x 109 mm
Weight	2 kg
Use	Indoors and outdoors No direct sunlight
Installation type	Suspended
Ambient temperature	-25 to +40 °C
Average ambient temperature over 24 hours	Max. 35 °C
Humidity	5 - 95%
Height above sea level	0 - 2,000 m

Wattpilot Home 11 J 2.0

Fronius Wattpilot – technical data	Home 11 J 2.0
Max. charging power	11 kW
Mains supply types	TT / TN / IT
Mains connection	5-pin cable
Nominal voltage	230 and 240 V (1-phase) / 400 and 415 V (3-phase)
Mains current (configurable)	6 - 16 A 1-phase or 3-phase
Grid frequency	50 Hz
Power consumption in standby	1.9 W (LED dark), 4.2 W (LED bright)
Charging socket	Type 2 infrastructure socket with mechanical lock
Residual current device	20 mA _{AC} , 6 mA _{DC}
Supply line cable cross-section	Min. 6 mm ²
RFID (radio frequency identification)	13.56 MHz
WLAN	IEEE 802.11b/g/n 2.4 GHz
Supported safety standards	WEP, WPA, WPA2, WPA3
Safety class	IP 65
Impact resistance	IK08
Dimensions (width x height x depth)	155 x 287 x 109 mm

Fronius Wattpilot – technical data	Home 11 J 2.0
Weight	2 kg
Use	Indoors and outdoors No direct sunlight
Installation type	Suspended
Ambient temperature	-25 to +40 °C
Average ambient temperature over 24 hours	Max. 35 °C
Humidity	5 - 95%
Height above sea level	0 - 2,000 m

Wattpilot Home 22 J 2.0

Fronius Wattpilot – technical data	Home 22 J 2.0
Max. charging power	22 kW
Mains supply types	TT / TN / IT
Mains connection	5-pin cable
Nominal voltage	230 and 240 V (1-phase) / 400 and 415 V (3-phase)
Mains current (configurable)	6 - 32 A 1-phase or 3-phase
Grid frequency	50 Hz
Power consumption in standby	1.9 W (LED dark), 4.2 W (LED bright)
Charging socket	Type 2 infrastructure socket with mechanical lock
Residual current device	20 mA _{AC} , 6 mA _{DC}
Supply line cable cross-section	Min. 2.5 mm ²
RFID (radio frequency identification)	13.56 MHz
WLAN	IEEE 802.11b/g/n 2.4 GHz
Supported safety standards	WEP, WPA, WPA2, WPA3
Safety class	IP 65
Impact resistance	IK08
Dimensions (width x height x depth)	155 x 287 x 109 mm
Weight	2 kg
Use	Indoors and outdoors No direct sunlight
Installation type	Suspended
Ambient temperature	-25 to +40 °C
Average ambient temperature over 24 hours	Max. 35 °C
Humidity	5 - 95%
Height above sea level	0 - 2,000 m

Status codes and remedy

Status Codes

Due to phase, voltage and switching function checks of the Fronius Wattpilot, a charging operation may be rejected.

The status codes are displayed via the LED status indicator (see [LED status indicator](#) on page 17) directly on the Wattpilot and in the app under "Status".

1 - Fault current detected (LEDs light up pink, the LEDs at the top flash red)

Cause: The residual current device has detected an error.

Remedy: The charging equipment in the vehicle may be defective. Have the charging equipment checked by a specialist.

Remedy: Disconnect and reconnect the charging cable.

3 - At least one phase of the power supply is missing (the LEDs light up blue, the LEDs at the top flash red)

Cause: The device is only being supplied with 2 phases.

Remedy: Make sure that phase 2 and phase 3 are connected correctly. Option: a supply via phase 1 only is possible.

8 - Grounding fault detected (the LEDs light up green and yellow, the LEDs at the top flash red)

Cause: Grounding fault detected.

Remedy: Check that the connection is properly grounded.

10 - Relay fault detected

Cause: The relay has not switched.

Remedy: Disconnect the power supply to the device for 5 seconds.

11 - Backup power mode detected

Cause: 53 Hz mains current detected.

Remedy: Observe the instructions in the Operating Instructions.

12 - Type 2 plug locking failed

Cause: The plug locking system does not work.

Remedy: Remove possible foreign parts in the plug housing.

Cause: Type 2 plug not fully inserted.

Remedy: Insert the type 2 plug into the device as far as it will go until you hear a click.

13 - Type 2 plug unlocking failed

Cause: The electric vehicle is plugged in.

Remedy: Unplug the electric vehicle.

Cause: "Always locked" under "Cable release" in the Solar.wattpilot app is activated.

Remedy: Deactivate "Always locked" under "Cable release" in the Solar.wattpilot app.

Cause: Release jammed.

Remedy: Insert the type 2 plug into the device as far as it will go until you hear a click. If the problem has still not been fixed: Press the push button on the device. If the problem has still not been fixed: Activate and save "Always locked" in the Solar.wattpilot app, then activate and save "Standard mode" under "Cable release".

100 - Internal communication error (all LEDs flash red)

Cause: Device is not sending data.

Remedy: Disconnect and reconnect device.

Remedy: Perform a firmware update.

Remedy: Return device.

101 - Temperature too high (the LEDs light up yellow, the LEDs at the top flash red)

Cause: Continuous load.

Remedy: Disconnect device and allow to cool down.

Cause: Incorrectly installed cables.

Remedy: Disconnect device and allow to cool down.

105 - No data available on the flexible electricity tariff (first or second LED - Eco Mode or Next Trip Mode - flashes red)

Cause: Flexible electricity tariff cannot be called up.

Remedy: Check WLAN and Internet connection.

Remedy: Wait until the server is available again.

109 - No connection to the inverter (first or second LED - Eco Mode or Next Trip Mode - flashes red)

Cause: The connection to the inverter cannot be established.

Remedy: Check the network settings.

Remedy: Check the settings of the inverter.

114 - For Eco Mode, PV surplus or flexible electricity tariff must be activated (Eco Mode LED flashes orange)

Cause: Eco Mode is selected and the "Use PV surplus" and "Use Lumina Strom / aWattar" settings are disabled.

Remedy: Activate the setting "Use PV surplus" and/or "Use Lumina Strom / aWattar".

Remedy: Change the mode.

Cause: "Use Lumina Strom / aWattar" is enabled and there is no data connection to the Internet. Cached price data is still available.

Remedy: Check the network settings.

115 - The set amount of energy cannot be reached in the specified time (second LED - Next Trip Mode - flashes orange)

Cause: The specified time is not sufficient for the desired amount of energy.

Remedy: Extend the specified time for charging.

Remedy: Reduce the desired amount of energy.

116 - Update of flexible electricity tariffs failed (first or second LED - Eco Mode or Next Trip Mode - flashes orange)

Cause: The connection cannot be established.

Remedy: Check the network settings.

The charging operation cannot be started, but all LEDs show the ready colour (default blue).

Cause: The vehicle is not being detected.

Remedy: Check vehicle cable and fit of charging plugs

No LEDs light up after plugging in.

Cause: No power on the junction box.

Remedy: Check the overload fuse of the connection.

Cause: Miniature fuse defective.

Remedy: Check the miniature fuse on the rear of the device. If it has melted, the power connection may not be installed properly. Check the polarity of the power connection before starting another test with a new miniature fuse. Use original miniature fuses only.

Cause: The brightness of the LEDs has been set to 0.

Remedy: Increase the brightness of the LEDs in the Fronius Solar.wattpilot app.

Cause: "Switch off LEDs after 10 s in standby" has been enabled.

Remedy: Deactivate "Switch off LEDs after 10 s in standby" or press the push button on the Wattpilot.

Warranty terms and conditions, and disposal

Fronius manufacturer's warranty

Detailed, country-specific warranty conditions are available on the internet www.fronius.com/solar/garantie

Disposal

Waste electrical and electronic equipment must be collected separately and recycled in an environmentally responsible manner in accordance with the EU Directive and national law. Used equipment must be returned to the distributor or through a local, authorised collection and disposal system. Proper disposal of the old device promotes sustainable recycling of material resources. Ignoring this may lead to potential health/environmental impacts.

Packaging materials

Collected separately. Check your municipality's regulations. Reduce the volume of the box.



fronius.com/en/solar-energy/installers-partners/products-solutions/monitoring-digital-tools

**MONITORING &
DIGITAL TOOLS**

Fronius International GmbH

Froniusstraße 1
4643 Pettenbach
Austria
contact@fronius.com
www.fronius.com

At www.fronius.com/contact you will find the contact details of all Fronius subsidiaries and Sales & Service Partners.